



# INTRODUCTION

More than one year has elapsed since the publication of the last ALBA newsletter.

Since then, many things have occurred as you will see in the forthcoming pages. The ALBA building is near completion, the LINAC was received and installed last July and after a couple of months commissioning has been completed. Many accelerator components are presently stored in the ALBA warehouse waiting to be installed.

The insertion devices are being manufactured, the vacuum chambers for the front ends are also in their production phase. The installation of the booster synchrotron and later of the storage ring will start next January and will go on for the whole year.

Some of the beamline optical components of the seven beamlines are in their detailed design phase and other are ready for delivery.

The beamline infrastructure consisting in personnel protection lead hutches, mechanical installations and cabling are underway. By next June all of them should be ready, some of them before.

The activity of the staff is evolving from being centered at the offices of the University Autonomous to the ALBA site. By next spring it is planned that all the personnel will be located at the ALBA building.

The whole process of assembly of the laboratory is going rather smoothly although some difficulties have been encountered related to respecting previously defined time schedules.

Delays of several months on some activities have occurred and efforts are being done to reduce them as much as possible. It is intended to have photons at the optical elements for commissioning and starting experiments by the end 2010.

The assembly of the accelerator, beamlines and associated infrastructures will certainly keep all the ALBA staff very busy in 2009.

ALBA has presently 132 employees distributed in 22 nationalities as illustrated in the figure below:

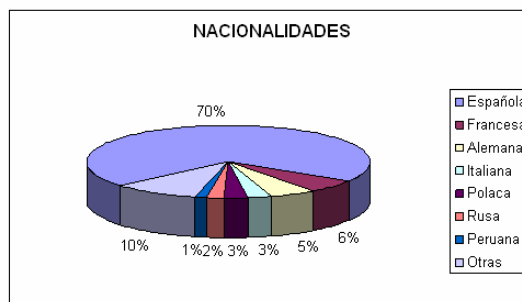
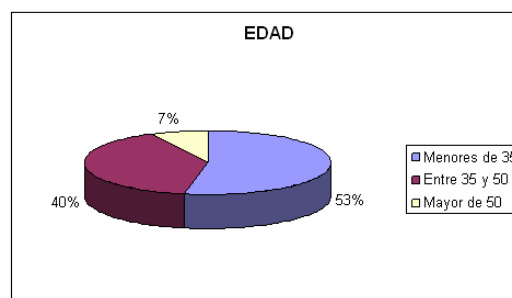

Fig. 1: Distribution of the nationalities of ALBA staff.

In addition to the regular staff members, 13 additional persons have been temporarily contracted in Spain plus 19 more coming from Rusia (Budker Institute) and the Czech Republic to participate in the accelerator assembly

ALBA is a young facility with a young staff :



from which 81 % are male and 19 % female.

Regarding financial aspects of the project, more than 80% of the planned contracts have already been awarded and refer mainly to the building and accelerators which have practically completed their contractual tasks. The remaining 20 % correspond mainly to the Experiments Division which include contracts for the end stations of the beamlines and detectors.

## TIMING

The table next page shows a summary of the presently foreseen time schedule of the installation along 2009 and 2010.

During 2009 the mechanical installation of the Booster synchrotron will take place until March-April . By July the Booster should be finished including its control electronics. A 2-3 week pre-commissioning it is foreseen. The mechanical installation of the storage ring (SR) will start in April and it will be finished by November approximately.

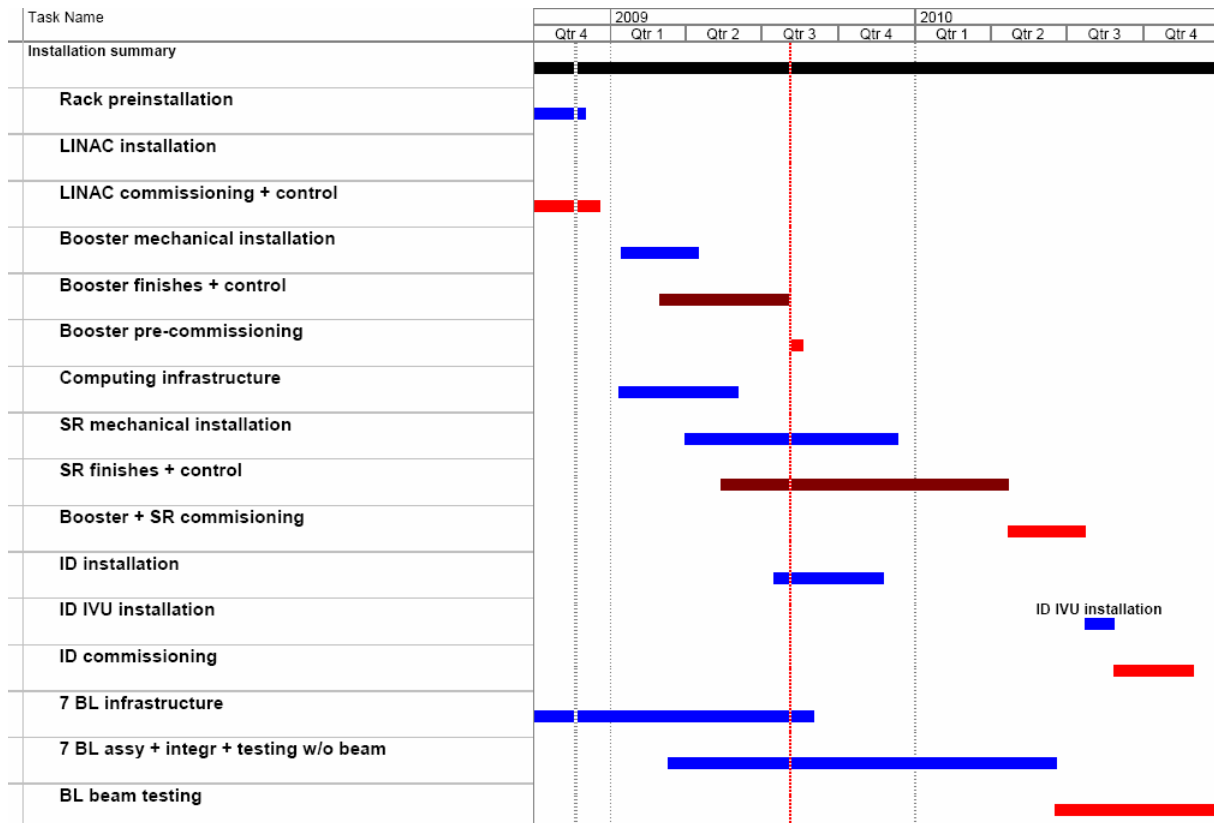

The first quarter of 2010 will be devoted to commissioning the control electronics of all the SR ring components. The second quarter, will be devoted to the commissioning of the booster and SR.

The insertion devices will be installed in two phases. Firstly the wigglers and undulators that do not have magnets inside the vacuum chambers as the conventional wiggler for beamline 22, the helical undulators for beamlines 24 and 27 and the superconducting wiggler for beamline 4 and secondly the in-vacuum undulators for beamlines 11 and 13 which will be installed in autumn. The fourth quarter of 2010 will be devoted to commissioning of the insertion devices.

In parallel with the activities of the accelerator, the infrastructures of the beamlines (safety hatches, electrical and fluids installations) are planned to be completed by summer 2009 approximately although the installation of some optical components of the beamlines as the monochromators and mirrors of beamlines 11, 13 and 24 will start before.

By the end of 2009, it is foreseen to have all the optical components of all the beamlines installed and ready for commissioning. The end stations of the different beamlines should be completed by autumn 2010.

## CIVIL ENGINEERING

The power supply to CELLS has been specified to be redundant. To achieve such a requirement and have the required electrical stability, the supply will consist of the elements indicated in the figure 2.

CELLS will be connected by a double electrical line of exclusive use to Codonyers 220kV/25kV electrical substation. The transformers at the substation as well as the high voltage positions are also of exclusive use.

CELLS will also be connected to the cogeneration plant ST4 which will provide to CELLS electrical power, warm and chilled water. The connections are also of exclusive use to CELLS.

With such scheme CELLS will have the possibility to operate with the electrical public network at transport voltage by means of the connection to the substation or if necessary isolated from the public network by using the cogeneration plant.

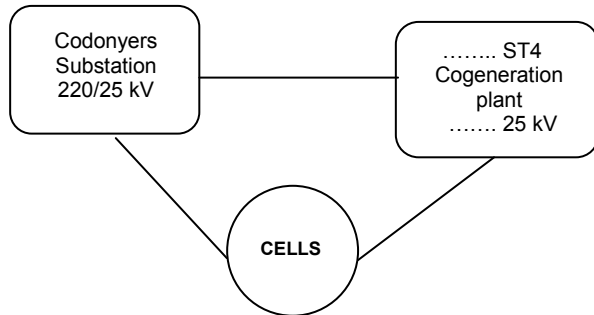

**Fig.2: Electrical Supply**

The current schedule of the works predicts that the electrical substation will be operative by December 2009. The Cogeneration plant should be ready for commissioning by March 2009, but the final operation can only be carried on with the electrical substation fully operative which implies that the scheme described above will be operative by December 2009.

In the meantime, CELLS has taken actions to get a temporary electrical supply up to 6 MW which is already operating and it is sufficient for the commissioning phase of the project up to the availability of the final redundant configuration.

## STATUS OF THE BUILDING AND INFRASTRUCTURES.

The construction activities in the building have progressed substantially in the last few months and they should be practically completed by the end of 2008.

The following pictures illustrate some recent aspects of the construction works.



**Fig.3: View of the service area at the inner part of the storage ring tunnel. The workers are installing supports for the cable trays that will be connected to the electronic racks mounted on a false floor on top of the metallic structures of the photograph. Date: 2 Dec 08**



**Fig.4: The Control Room, illuminated in the photograph, is located in the first floor above the Experimental Hall. The photo also shows the peripheral pipesthat will carry demineralized water to the beamlines r for cooling purposes. Date: 2 Dec 08**



**Fig.5: Inside the tunnel that will house the storage ring and the booster. The square holes visible on the concrete walls are for alignment (top) and for the exit of the synchrotron beam (bottom). The tubes at the left hand side are the cooling lines for the magnets of the storage ring. The first semicircle has already been cleaned and it is ready for mounting magnets and vacuum chambers. The large ducts on the upper right hand side belong to the climatization unit. The right angle brackets attached to the right wall are the supports for the bending magnets of the booster. Below them, the cable trays and water cooling lines are visible. Date: 2 Dec 08**



**Fig.6 and 7: Views of the experimental hall during the preparation of the installation of the safety hutch of beamline 13. The photos also show the safety hutch of BL 11 (violet) already finished and the two orbital cranes .Date: 2 Dec 08**



**Fig.8: View of the vacuum laboratory located at the external perimeter of the building. The vacuum chambers of the booster are pumped down, baked and leak tested to prepare them for mounting in the tunnel. Date: 2 Dec 08**



**Fig.9 Several vacuum chambers tested and ready for mounting.**

# ACCELERATOR DIVISION

The accelerator division has been busy during 2008 with the installation and commissioning of the Linac (which is finished) and carrying out the factory acceptance test of most components for the accelerators as well following up the production of the rest of the components. Most of the components already delivered and stored in the warehouse (see Fig.10). The tunnel (see Fig.11) is already cleaned and the first activities have already been started.

We are now preparing the assembling and installation of the booster synchrotron as well the storage ring. The installation of the booster has already been started with putting the positioners on the brackets and mounting all ground plates for the booster tables on the floor. We hope that we can start the pre commissioning of the booster synchrotron in the middle of next year .

## BEAM DYNAMICS

The Beam Dynamics Section has spent a lot of effort during 2008 in order to prepare for commissioning of both Booster Synchrotron and Storage Ring. Several visits have been organised to other facilities (Diamond, SOLEIL, Stanford among others) to learn from their commissioning and to see how their experience can be used for ALBA. The Matlab MiddleLayer package, widely used in other laboratories (Spear, ALS, Soleil, Diamond, CLS, ...) has been adopted for commissioning, and a full implementation of the ALBA machines has been produced.

A detailed analysis of the effect of the higher order multipoles, obtained as results of the magnetic



Fig.10: Boxes with the components of the accelerator complex of ALBA stored in the ALBA warehouse.



Fig.11: View of the tunnel which will host the Booster (right side) and the Storage Ring (left side).

measurements, in the quadrupoles and sextupoles of the Storage Ring has been performed, with the results there is not any influence of the higher multipoles upon the performance of ALBA. The analysis of the magnetic measurements of the bending magnets of the SR shows that there is not any significant higher multipole in the so called good field area (see Fig.12). According to the magnetic measurement of the storage ring bending magnet a sorting of the magnets has to be done in order to reduce the closed orbit deviations from 10 mm to roughly 1 mm.

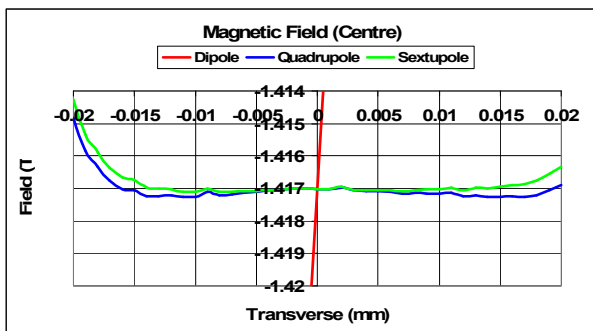

Fig.12: Field distribution in the middle of the bending magnet with the values: ( $B_0 = -1.411375$  T,  $G_0 = 5.642$  T/m and  $B'' = -0.7$  T/m<sup>2</sup>)

## INJECTOR

This has been the big year for the Linac. At the beginning of the year all pieces were ready to be packed and sent to ALBA and the installation of the linac started at the beginning of January 2008 (see Fig.13). On the 3<sup>rd</sup> of March the Linac was installed into the Linac bunker.

The installation of the transfer line from the linac to the booster (within the Linac bunker) as well the

diagnostic line was the responsibility of ALBA (see Fig.14).



Fig. 13: The Linac is being lowered into the Linac bunker

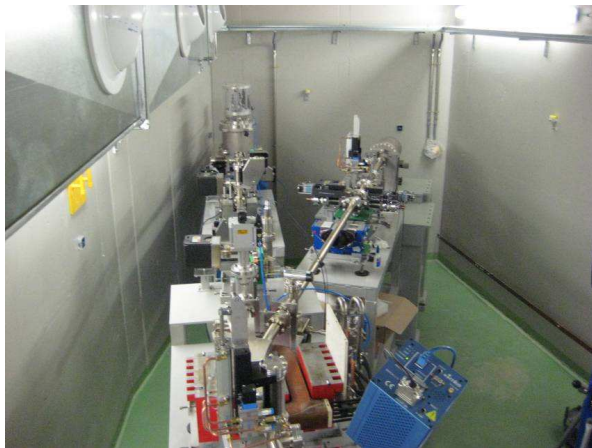

Fig 14: LTB Transfer line (left) and the diagnostic line (Right)

After that, THALES Communications S.A. and CELLS have worked side by side to install the Linac, the transfer line and to connect the infrastructure like water cooling and electrical supply. For the cooling as well for the electricity we had to use temporary solutions because the final one is still under construction. At the end of May the conditioning of the two accelerating cavities started and on the 3<sup>rd</sup> of July the first 100 MeV electron beam at the Linac exit was observed (see Fig.15).

After a summer break commissioning was resumed and the final Acceptance Test took place middle of October. The parameters reached in the Linac are summarised in the table below (see table 1) where they are compared to the design values:

The Linac therefore fulfils all the specifications but a final optimizations has still to be done. We are now waiting for next year to start it up again with

the definitive supply of cooling water and of electrical power. At that time we will tune the Linac adequately so as to achieve an optimised performance for injection into the Booster.



Fig. 15: First beam at the Linac exit (3<sup>rd</sup> of July late in the eve-

| Parameter                       | Specs                                   | Measured                      |
|---------------------------------|---|-------------------------------|
| Charge                          | $\geq 3\text{nC}$ (in 1 $\mu\text{s}$ ) | 4 nC (in 112 ns)              |
| Energy                          | $\geq 100\text{MeV}$                    | 107 MeV                       |
| Pulse to pulse energy variation | $\leq 0.25\%$ (rms)                     | 0.06 % (rms)                  |
| Relative energy spread          | $\leq 0.5\%$ (rms)                      | 0.23 % (rms)                  |
| Normalised emittance            | $\leq 30 \pi \text{ mm mrad}$           | $\leq 30 \pi \text{ mm mrad}$ |
| Pulse to pulse time jitter      | $\leq 100\text{ps}$ (rms)               | 25 ps (rms)                   |
| Repetition rate                 | 3 - 5 Hz                                | 1-3 Hz                        |

Table 1: The main linac parameters according to the specifications as well the measured values

## MAGNETS & POWER SUPPLIES

All magnets (booster synchrotron: 40 bendings, 12 quadrupoles, 16 sextupoles, plus corrector; storage ring: 32 bendings, 112 quadrupoles, 120 sextupoles plus correctors) have been received at CELLS. All of them are stored in the ALBA warehouse and waiting for installation (see Fig.16). All the quadrupoles and sextupoles have been measured and the higher multipoles of the quadrupoles and sextupoles are within their specifications. Most of the measurements have been done at the manufacturer but some of them have been measured at Soleil and NLS at Brookhaven laboratory too. The results, measured at SOLEIL (see Fig.8) are really promising, most of the higher multipoles are in the range of  $1 \cdot 10^{-5}$  in relation to the fundamental, which means they are producing at a radius of 25 mm a field of 0.003 mT, which is really negligible.



Fig. 16: View of the SR quadrupoles and sextupoles stored in the ALBA warehouse and waiting for installation.

At the beginning it was not foreseen to perform magnetic measure all the quadrupoles for the booster synchrotron but relying on the mechanical measurements.

At the beginning of this year CELLS got the chance to buy a rotating coil bench from CERN and according to this opportunity we made also the magnetic measurements of all quadrupole magnets. Some results are given in Fig. 17 obtained with the rotating coil bench shown in Fig.18.

For the combined booster synchrotron the average of the ratio given in Fig.19 is 0.0199, the theoretical value should be 0.0202; this is really a good result.

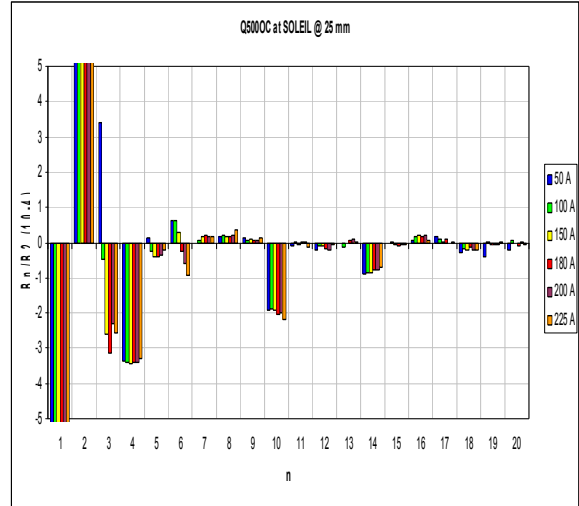

Fig.17: Ratio of the higher multipoles to the fundamental one for the storage ring quadrupole with a length of 500 mm.

Because of some delays for the building we are using the extra available time ( until the installation of the components starts) in order to make more measurements for understanding the performances of the components much better, for example we started also a big magnetic measurements campaign (field mapping) for the booster bending magnet and found that the fringe field angle, which makes a vertical focussing, is far away from the design value.

This can be compensated by changing the gradient in the bending magnet. A solution is under investigation.

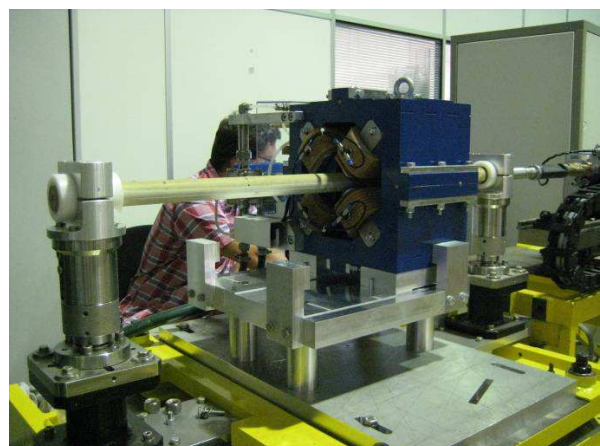

Fig.18: Rotating coil system for the magnetic measurements of the booster quadrupoles



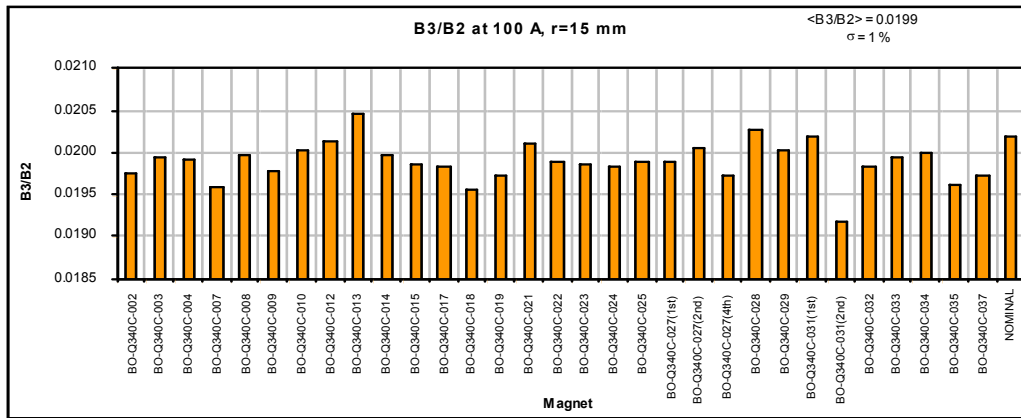

Fig.19: Ratio of the sextupole to the quadrupole component of the combined booster synchrotron.

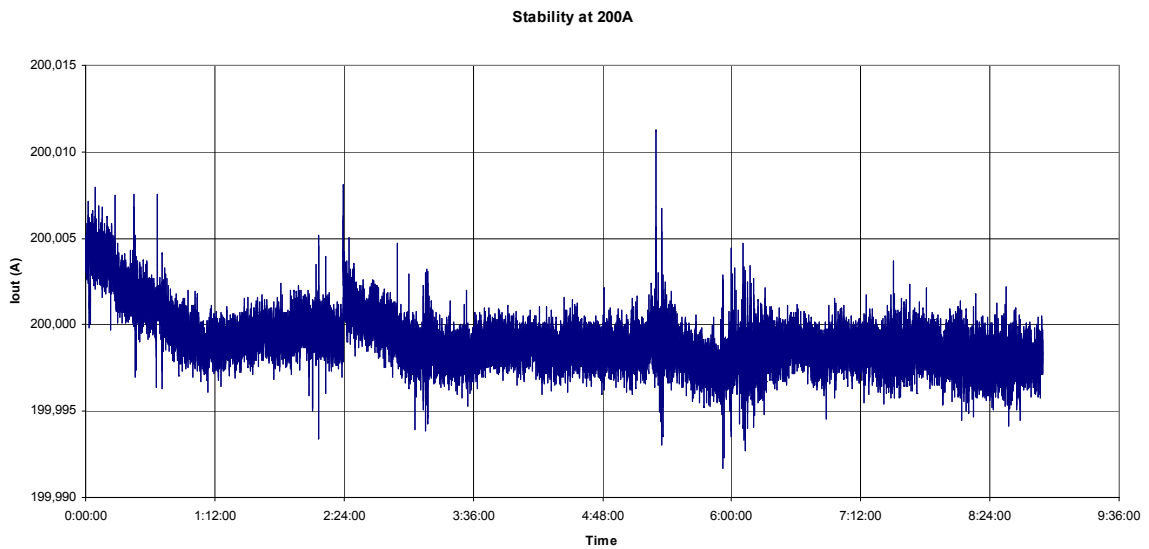

Fig.20: Long term stability of the sextupole power supply

Concerning the power supplies those for the Storage Ring will be received by the end of this year, while those for the Booster are expected by the beginning of next year. The factory acceptance tests for all the storage ring power supplies were successful (Fig.20). The fast corrector power supplies will also be delivered by the end of this year.

The measurement of the beam charge and beam position within the linac and the LTB (Linac to Booster)-transfer line are shown in Fig.21. that shows also the setting of the Quadrupole in the LTB. By changing the setting of the quadrupole also the beam positions within the LTB are changing, which means that the beam is not going through the middle of the quadrupole.

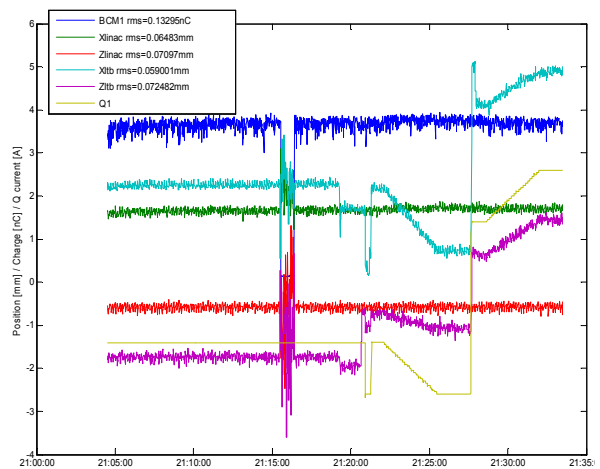

Fig.21: Beam position and beam charge measured with the BPM system and the beam charge monitor.

## RADIO FREQUENCY

The RF system for the storage ring consists of 6 units as given in Fig.22. All the components have already been delivered (see Fig. 23) and waiting for the installation.

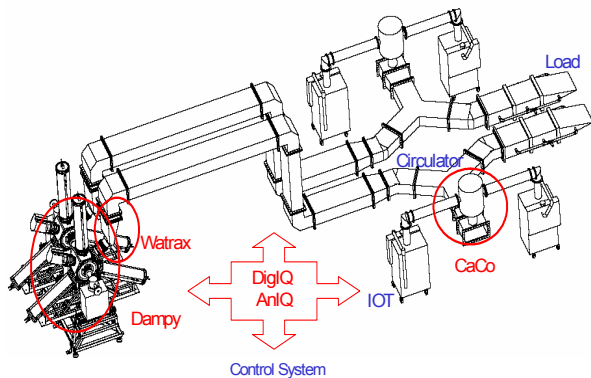

Fig.22:Components of the ALBA storage ring RF-system

Missing are the last cavities, coming from ACCEL, and the circulators coming from Ferrite.

In our present RF Lab, all the RF subsystems have been tested and a power test of a complete plant up to 80 kW has been realised.

During the testing of the cavity prototype it was found that the temperature at the flanges between the cavity body and the damper was increasing more as expected. Accordingly, some design changes have been introduced and the results of this changes will be available pretty soon.



Fig. 23: RF Transmitters stored in the warehouse

## VACUUM

The booster vacuum chambers are being assembled and baked out in a temporary lab in the ALBA building and will be ready for the installation by the beginning of 2009.



Fig.24: factory acceptance tests of the storage ring vacuum chambers, the bakeout oven and the strong back.

CELLS received 50% of the storage ring vacuum chambers, and the delivery will finish by the end of February 2009, several chambers were tested at CELLS (tests include vacuum tests, dimensional check, magnetic permeability tests...etc). All the tools needed for the assembly of the storage ring vacuum chambers have been delivered and tested at CELLS to validate the assembly procedure.

Concerning the standard vacuum components; all the gauges and residual gas analysers were delivered, almost all the ion pumps and all the controllers are at CELLS, the NEG pumps and the UHV valves were delivered too.

## INSERTION DEVICES

The insertion devices for Phase-I beamlines are all in construction: two Apple-II Undulators in Elettra, a superconducting wiggler, SC-W31, in BINP, two IVU-21 are being built at ACCEL and the normal conducting wiggler is being developed and built at ADC (USA). Fig 25 shows the EU62 Apple-II undulator frame. The frame and the control system have already been assembled and tested and magnetic assembling and shimming will start in mid November. We expect to take reception of all these ID's during the first half of 2009.

Fig.25: EU62 Apple-II undulator frame.



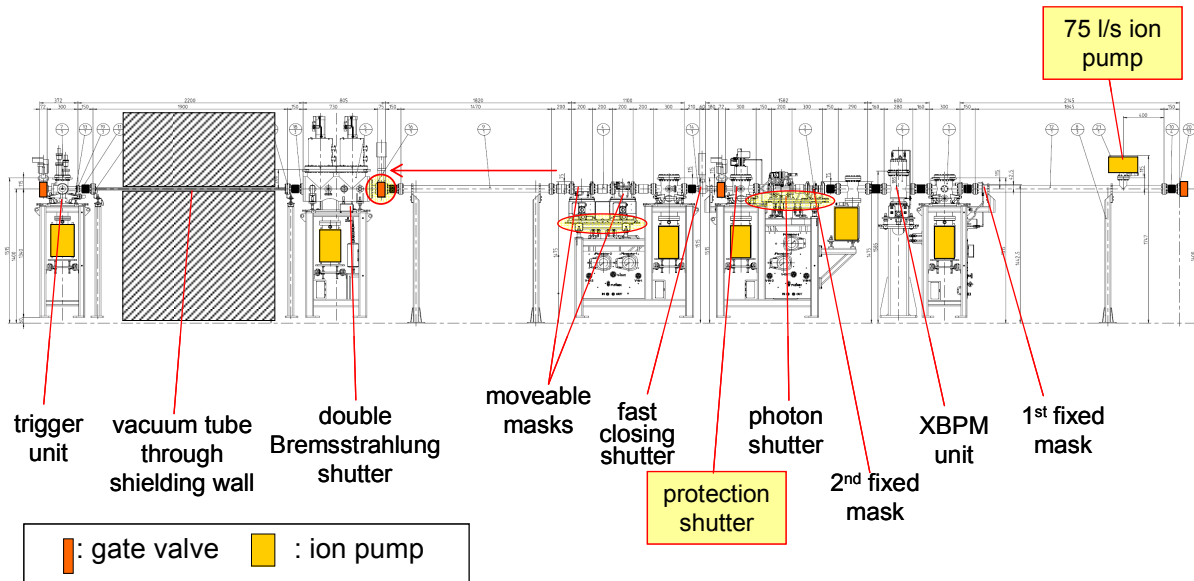

Fig.26: Layout of the ALBA front ends

### FRONT ENDS

The layout of the front end is shown in Fig. 26. The design for the Front Ends was closed in March 2008. The Factory Acceptance Tests for some of the components have already taken place and the contract will be completed early next year.

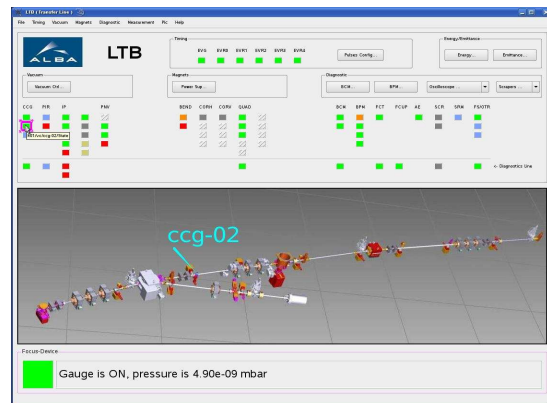

Fig.28: The main GUI of the LTB

## COMPUTING NEWS

### INSTALLATION PROGRESS THE LINAC TO BOOSTER TRANSFER LINE

Since the last newsletter we have successfully commissioned the Linac and the Linac to Booster transfer line (LTB). The Linac has been purchased together with its local control system turn-key from Thales. The integration of this control system will be a subject of a future newsletter. The LTB



Fig.27: One pre-installed rack

however has been served not only for the site acceptance test of the Linac, but also as a first "real live" application of the ALBA control system, standard electronics, and the cabling and installation procedures.

The LTB control system comprises vacuum, interlocks, synoptic panels, power supplies, the Sardana Device Pool, archiving, etc. Motion control, counter devices, scans and basic online data analysis, particularly interesting for beamlines, have also been successfully used in the transfer line. In total, more than 60 device servers are running on the LTB control systems and many GUIs have been written to allow the control and the supervision of all the LTB components.

The electronic for the LTB is installed in 6 racks from Schroff. The installation procedure which has been adapted resembles closely the installation procedure of the booster, storage ring, and the beamlines. First the requirements have been collected from the users. These requirements have then been combined with the ALBA standards and entered in the cabling data base. This database then served as the basis for the pre-installation of the electronic racks in the warehouse and to out-source the cabling to an external company. The cabling was done by Cobra during May and June 2008. This installation helped us to refine the procedures for the future installations.

## CABLING

The cabling project has been a major activity for all sections inside the computing and control division. We have spent many months collecting information from the instrument responsible. We have entered most of this information concerning equipments and cables into our cable data base (CDB). This cable data base has been developed by the Management Information Services (MIS) section. It is adapted to our needs at ALBA. One of its first usages was to generate all the necessary reports for the cable call for tender. The CDB is the central repository for all racks, equipment and cable and all their documentation. The CDB is also used for the installation and management of cables, equipment and racks, the automatic code generator for PLCs of the equipment protection system and the certification of equipment tests. With a valid intranet account, you can have a look at all this information, reports and documentation at: <http://www.cells.es/Intranet/MISApps/ccdb>.

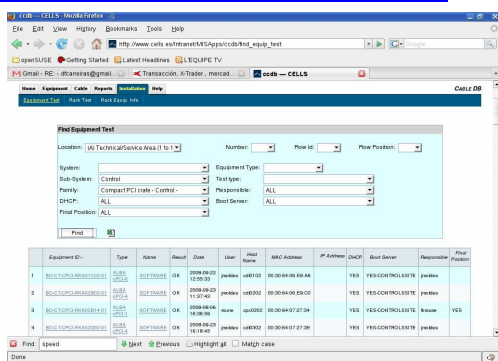

| Equipment ID | Type             | Name             | Result | Date                | User  | Unit   | MAC Address       | IP Address | DHCP | Boot Server      | Preprocessor | Prep Position |
|--------------|------------------|------------------|--------|---------------------|-------|--------|-------------------|------------|------|------------------|--------------|---------------|
| 1            | RECI-CONTROL-001 | RECI-CONTROL-001 | OK     | 2008-08-27 12:00:00 | jesus | 480102 | 00:30:84:08:80:A8 |            | YES  | YES-CONTROL00176 | jesus        |               |
| 2            | RECI-CONTROL-002 | RECI-CONTROL-002 | OK     | 2008-08-27 11:29:00 | jesus | 480302 | 00:30:84:08:ED:0C |            | YES  | YES-CONTROL00276 | jesus        |               |
| 3            | RECI-CONTROL-003 | RECI-CONTROL-003 | OK     | 2008-08-27 10:00:00 | jesus | 480502 | 00:30:84:07:27:24 |            | YES  | YES-CONTROL00376 | jesus        | YES           |
| 4            | RECI-CONTROL-004 | RECI-CONTROL-004 | OK     | 2008-08-27 10:00:00 | jesus | 480302 | 00:30:84:07:27:28 |            | YES  | YES-CONTROL00376 | jesus        |               |

Fig.29: Report from the cabling database concerning the pre-installation of IOCs

Currently the cable data base contains more than 300 racks, 5000 equipments and 13000 cables. We have taken this information and an estimation of the beamlines cabling to prepare the cable call for tender. In this contract we will include the parts of the cable trays not yet delivered as part of the building, the cabling of the magnets and the signals, and the false floor. We are currently analyzing the offers and expect awarding as early as November.

The detailed design of the cable trays for the machine and some of the beamlines is finished. Many tasks to prepare a successful installation campaign are currently in progress.

## RACK PRE-INSTALLATION

We will have to install almost 400 electronic racks for the machine and the beamlines. A task in this order of magnitude can only be carried out successfully by assembling and testing the racks already in beforehand.

We have therefore conditioned an area for the rack pre-assembly in our warehouse. In this area, we install all the accessories for the racks (L-guides, trays, etc), and all the equipments with their internal cables. We finally power-up the rack. All this information is uploaded into the cable database.



Fig. 30: Rack pre-installation area

Every electronic rack in the service area will be installed on its individual support. These supports have been constructed, installed in the service area, and finally aligned.

A very powerful network boot system using PXE has been set up for more than 100 diskless compact PCI control systems. It also serves as installation server for 10 different Linux operating systems. At the moment we are implementing a Windows install procedure over the network. Network installations need less intervention and are therefore much faster.

## PREPARATION WORK FOR THE BEAMLINES

We have organized a review with all the beamline software contacts about the design of the beamline control software. To facilitate the discussion with the beamline scientists, simulators and mock up GUIs have been created. These efforts have been reported to SAC. It is planned to hold similar meetings in the near future to follow up the developments.

The factory acceptance tests for the optics of the beamlines are in progress. The IcePap motor controller has proven to work well and has been successfully integrated with the motors provided by the different manufactures.

## NETWORK

As active elements of the computing network more than 100 full wire speed (1Gbit and 10Gbit) switches from Extreme Networks (Summit X450e for peripheral and the BlackDiamond 8810 as redundant core switches) have been purchased, many of them are already configured and installed in the pre-installation campaign of the racks in the

accelerator service area.

CELLS disposes today of more than 10000 public IP addresses.

We started to provide integrated network and phone services at the construction site, in the warehouse, in the temporal offices, at the Linac, and at the vacuum lab with many temporal installations of fiber optics cables. The implementation of a wireless network which will cover the whole site started with the installation of the first three Wi-Fi access points. Up to now we still have a microwave antenna connection but in a few days the site will be connected to the Spanish scientific network RedIRIS by a 500 Mbit/s link to CESCO.

## SOFTWARE AND HARDWARE DEVELOPMENT

### ELECTRONIC DESIGNS

During the last months, we have developed several electronics designs. We have implemented a Fast Interlock Module for the Radio Frequency stations. That system is capable of time-stamping interlocks with a resolution of 1 $\mu$ s. As one interlocks very often leads to other interlocks, this will help enormously to identify the source of a problem.



Fig.31: RF Fast Interlock

In order to have a standard electrical interface to our electronics, we have developed EMC patch-panels for the data acquisition boards (ADCs, DACs, DIOs, and CCDs) and interfaces between the IcePap motor controller and brakes and absolute encoders.



Fig. 32: Patch panels

We have also built a signal conditioner for the Beam Loss monitor of Cosylab and an interface between the Libera processors and the ALBA timing system.

To reduce the number of ion pump power supplies, the machine will use HV splitters developed in house (using commercial cards like Q-Lambda for HV and the Rabbit microprocessor board). The HV splitter splits the current of an ion pumps controller and reads the leak current of each branch. We are now mounting 80 of these units.

### PERSONNEL SAFETY SYSTEM (PSS)

The PSS ensures that nobody gets irradiated during operation. This comprises access control to bunkers, intrusion and malfunction detection as well as radiation level monitoring. It is based on Safety Programmable Logic Controllers (PLC) from Pilz, following the Safety Integrity Level 3 (SIL3) specified in the norm IEC 61508. The PSS for the Linac is fully operational since March 2008. The first phase of the installation of the PSS for the storage ring is about to be finished. The second phase will be accomplished in March before the commissioning of the booster. In the experimental hall, PSS sensors and detectors are also installed in the hutch of the NCD beamline.

### EQUIPMENT PROTECTION SYSTEM (EPS)

The equipment protection system manages permits and interlocks avoiding damaging the hardware. It is built on B&R PLCs with CPUs (more than 50!) installed in cabinets in the service area and distributed I/O modules installed in shielded boxes inside the tunnel. We have more than 180 boxes in total. The CPUs communicate with a deterministic protocol on an industrial Ethernet Powerlink with a cycle time of 2 ms. As there are more than 8000 signals (temperature, pressure, interlocks...) we have opted for automatic creation of code to the largest extend possible. The PLC variables are therefore generated from the cabling database, as well as the expert view graphical interface.

### THE SARDANA DEVICE POOL

Implementation of the Sardana device pool as the central application for the control of the beamlines and parts of the machine has continued to make good progress. The software package has found great interest in the major conference for beamline software NOBUGS. It is hoped to extend the excellent collaboration with DESY, ESRF, and ELETTRA to other institutes. The software has been successfully used to commission the Linac to Booster transfer line and in lab setups.

### CONTRACTOR PROFILE APPLICATION

In fulfilment of the Law 30/2007 about Public Sector Contracts, CELLS has created a web application to facilitate the access to the possible contractors and tenders to our Contractor profile. This application has improved the way we publish all our tenders and also the communication with all bidders. The application has got an integrated SMS notification system.

### EPURCHASING SYSTEM

A new system to process all purchase requisitions

has been implemented. This new system replaces the old paper forms with an automated web workflow. Orders can be tracked from the web, from the moment they were created to their delivery. The system allows users to request goods and services for any cost centre and assign the order to a specific project. Once the order is drafted, an approval workflow is generated and notifications sent. Cost centre managers have also access to a reporting tool where they can see their budgets and expenses. ePurchasing is completely integrated with our new finance system (SAP B1). The new ePurchasing system was launched in October and currently is being used by two divisions. In the next few weeks, we expect all CELLS to use it.

### SAP B1

This year has been dedicated to prepare the implementation of the new CELLS financial system in 2009. The customization of the new financial system (SAP B1) is now completed. This has been not an easy task as the system must comply with the public sector account system. All the necessary ADOP documents will be generated automatically. SAP B1 is not only a financial system but a full ERP. CELLS will use this system for many administrative areas: Finance, Suppliers Management, Purchasing, Cost Centres, Projects and HHRR. We are currently running SAP system in mode test and in parallel with our previous finance system.

### USER SUPPORT

One of the main activities in the computing and control division is to provide service to its more than 100 internal clients. The new trouble ticket

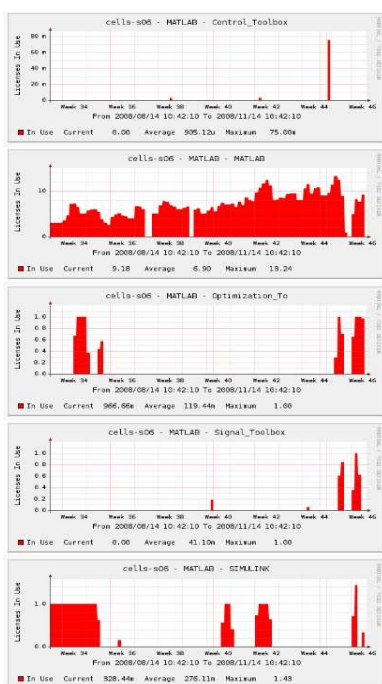

system "Request Tracker" (RT) helps us to adapt better to the needs of our users. Several RT queues for controls, electronics, MIS, and systems allow dispatching a ticket to the right section and person in the computing division. In order to detect problems before they have

an impact on our users we monitor central servers and services. We use Nagios for the observation of all servers (load, memory usage ...), the network, and the majority of services like e-mail and disk space. Cacti is used for collecting history data. Like this we can e.g. monitor the usage of licenses or the usage of processors in a server over a period of time.

## EXPERIMENTS DIVISION

### BEAMLINE 04

#### MATERIALS SCIENCE AND POWDER DIFFRACTION: MSPD

*The beamline will have the following key elements: a superconducting wiggler, a collimating mirror, a double crystal monochromator, a Kirkpatrick-Baez optics pair and two end stations: one for high resolution powder diffraction and another for high pressure diffraction experiments.*

A superconducting wiggler will enable the beamline to operate within a wide range of energies, from 8 to 50 keV. This energy range covers very well the desirable range for almost any powder diffraction experiment, and at the same time allows to perform high pressure diffraction. The optics of the powder station includes a collimating mirror and a double crystal monochromator, besides a focusing device (KB mirror) optimized for the high pressure station. After several meetings with external experts and Spanish user groups in the last two years the main decisions on the beamline layout are now taken and the design and procurement of the hardware is progressing well inside the ALBA project. After commissioning, the beamline will have two endstations: High Resolution Powder Diffraction and Powder Diffraction at High pressures using Diamond Anvil Cells. The layout of optics and experimental station gives considerable flexibility in the application of diffraction techniques including the later integration of a Single Crystal Diffraction option. To keep maximum flexibility in the layout of the endstations the integration of all components as well as the design of several important subcompo-

nents like Multicrystal Detector or beam conditioning are kept in house. The 3-circle Powder Diffractometer will have a state of the art design and is going through a Call for Tender procedure.

### OPTICS

The design of the optical layout and the specification of the individual components have long been finalized. The procurement is in progress passing the milestone of Preliminary Design Report where major design aspects are being approved. Avoiding vibrations under working conditions is critical for the optical elements performance.

particularly important in the case of the monochromator (see figure 33). As a consequence, the implementations of dynamic behaviour tests as well as vibration analysis (by FEA calculations) by Alba staff are part of the procurement process of the monochromator. All elements will be installed in the optical enclosure after the erection of the lead hutches in summer 2009.

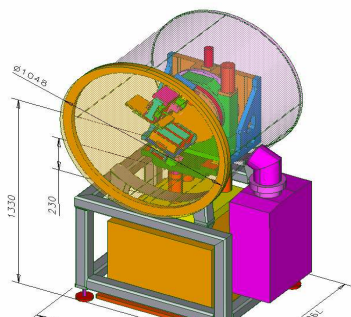

Fig.33: Monochromator model used for FEA calculations

### ENDSTATIONS

The Conceptual Design Report of the experimental endstations was presented during the first user meeting that took place at ALBA in October 2007. During this meeting the importance of the collaboration between the different interest groups was pointed out. Representatives from engineering, high pressure research, powder diffraction and the single crystal community as well as people from Alba attended this meeting with the goal to optimize the stations for the different needs. Also in view of the limited resources this coordination seems mandatory for the beamline to be at the forefront of material science research with synchrotron radiation. Some joint projects, like the design of in-situ reaction cells, have already started. The implementation of these cells is primarily driven by the EXAFS community.

### POWDER DIFFRACTION ENDSTATION

The powder diffraction endstation will have 3 con-

centric rotary stages (figure 34), with two detector systems installed: the high resolution Multi Crystal Detector and a 1-dim silicon strip detector for time resolved measurements. The installation of diffractometer and detector systems is planned for the beginning of 2010.

#### 3-Circle Diffractometer

The technical specifications have been published in the ALBA webpage and the Call for Tender was

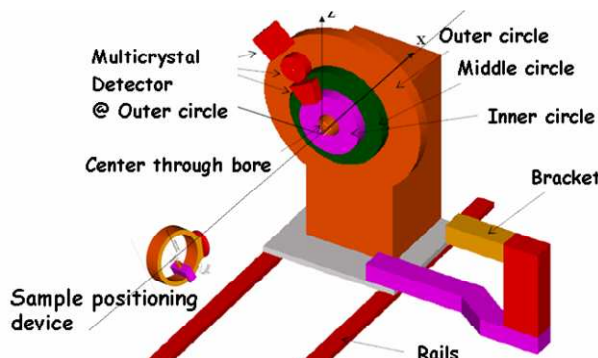

Fig.34: Schematics of the 3 circle diffractometer elements.

launched in October. A schematic of the diffractometer is shown in figure 34. The design will provide the Spanish scientific community with a diffractometer for high resolution powder diffraction experiments and at the same time presents the flexibility to perform in-situ experiments in different geometries. The main features will be i) high angular resolution ( $0.0002^\circ$ ), ii) flexibility to adapt different sample environments including horizontal and vertical translation of the whole diffractometer, and iii) stability and high load capacity. The tendering process is now in progress and the negotiations with the bidding companies will take place around the turn of the year.

#### The high resolution multi crystal detector system

The detector design is based on the multicrystal analyzer stage presented by Hodeau (1998 SPIE Vol. 3448) and first installed at beamline BM16 and now at ID31 (ESRF). The detailed design has been

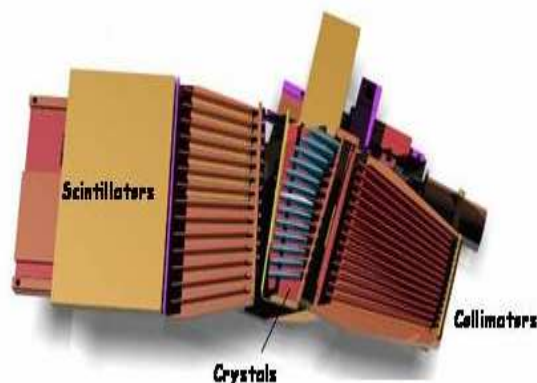

Fig. 35: High resolution detector system. The detector system has 13 Si111 analyzer crystals. Maximum beam dimensions: 7 x 2 mm.

The endstation will be integrated from commercial components and is designed in-house. Figures 36 and 37 show the current status of the beam conditioning unit upstream station 1 (High Pressure) and an earlier design of the station. The final installation of the endstation is planned for summer 2010.

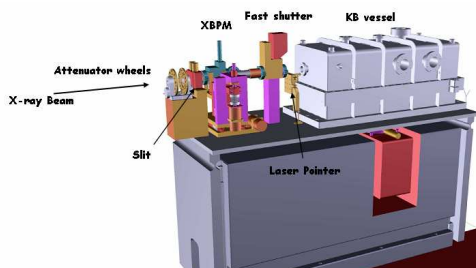

Fig.36: From left to right along beam propagation: beam conditioning elements and KB vessel.

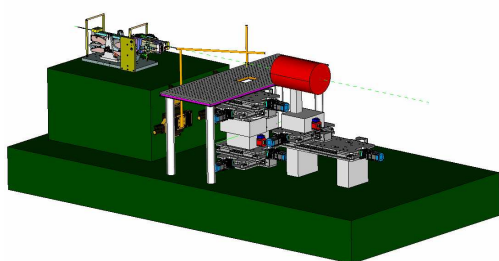

Fig. 37: From left to right along beam propagation: KB-mirror (without vessel), sample stage with table for auxiliary equipment, detector stage with area detector.

the gratings were signed between June and July 2008. Each contract is divided in 3 phases: Preliminary Design Review (PDR), Detailed Design Review (DDR) and Manufacturing Review (MR). The PDR has been already approved for all the contracts and DDR should be approved between the end of 2008 and the beginning of 2009. The components should be delivered in August 2009. The lead shielded hutch and the mechanical infrastructure installations will be set up before the arrival of the components.

### PRESENT STATUS OF THE END-STATION

The Transmission X ray Microscope (TXM) call for tender was published in March 2008. The contract was signed in November 2008 with Xradia Inc. (California, USA). Xradia will deliver a turnkey TXM for tomography with cryo sample stage in February 2010. The microscope will work from 270 eV to 1200 eV. A single reflection hollow glass capillary will be used as condenser lens (Zheng *et al.* Applied Optics 47, 2008) and a Ni Fresnel zone plate as objective lens. The microscope will also include a workstation to pre-load the samples into the microscope, a visible light microscope (VLM) online for rough positioning and a control and data acquisition software allowing for image visualization and tomographic reconstruction. Future upgrade for multi-keV energies (up to 2600 eV) is foreseen.

## BEAMLINE 09

### X RAY MICROSCOPY: MISTRAL

The MISTRAL beamline will be equipped with a full-field transmission X-ray microscope dedicated to cryo-tomographic imaging of biological samples. The samples will be illuminated with X rays from a bending magnet that will be focused by mirror optics and monochromatized by a stationary PGM (Plane Grating Monochromator) which will provide a constant output beam at all energies allowing to keep the sample position fixed from 270 eV to 2600 eV. Thanks to this, the microscope will also have the possibility to perform spectroscopic imaging and thus do chemical mapping.

### PRESENT STATUS OF THE BEAMLINE

The procurement of the beamline optics was organized in a call for tender exercise published in November 2007. It was divided in 4 lots: backbone, monochromator, mirrors and gratings. The contracts with CINEL (Italy) for the backbone, FMB (Germany) for the monochromator, SESO (France) for the mirrors and Horiba Jobin Yvon (France) for

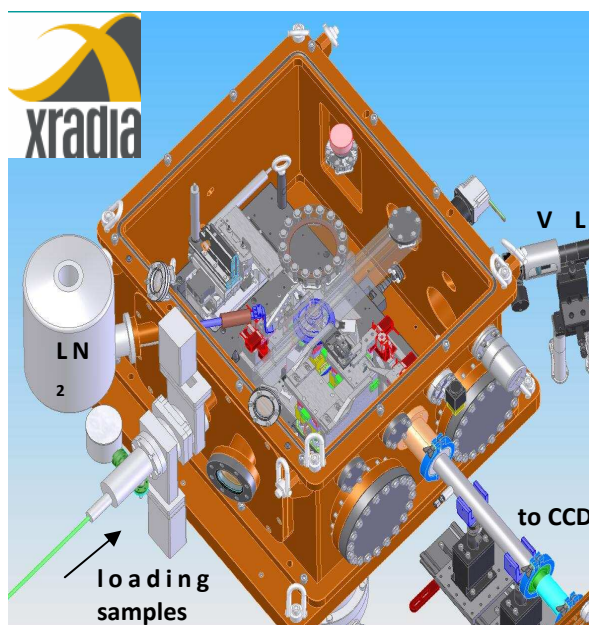
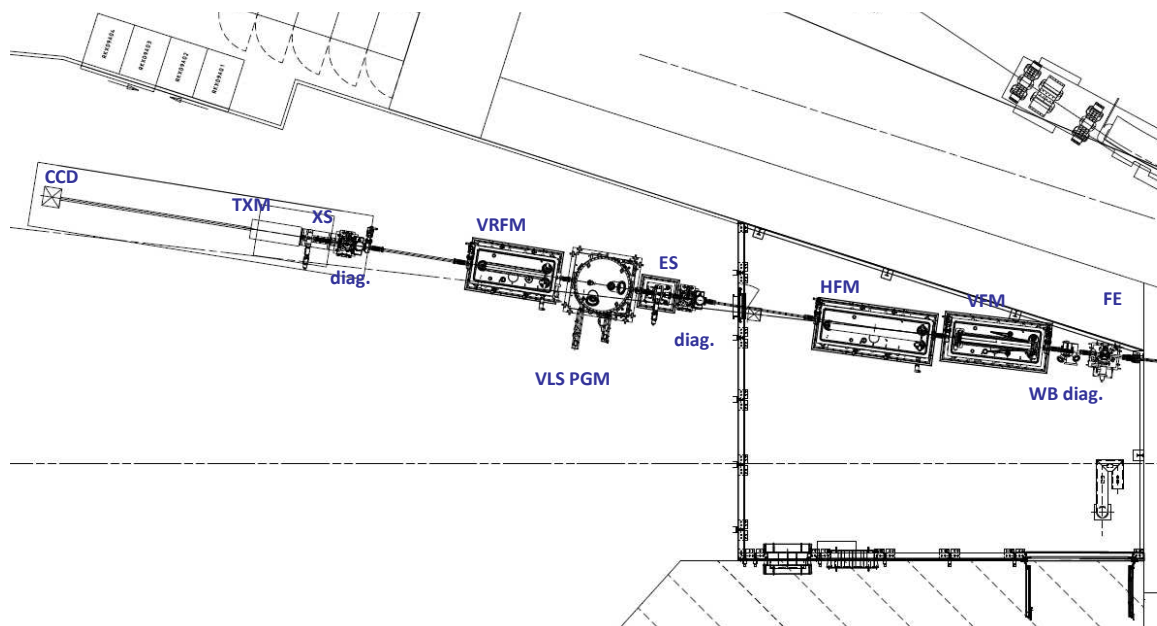

Fig. 38: TXM drawing (courtesy of Xradia)





**Fig. 39:** Beam line layout showing the Kirkpatrick-Baez mirror system (inside a lead shielded hatch), where the VFM (Vertical Focusing Mirror) focuses vertically on to the entrance slit (ES) and the HFM (Horizontal Focusing Mirror) horizontally on to the exit slit (XS). The vertically dispersing PGM is constituted by a plane mirror and two VLS (Variable Line Spacing) plane gratings. The PGM can work at constant magnification while ES and XS are kept fixed. An elliptical vertically refocusing mirror VRFM creates finally a secondary source at the XS position, which will illuminate the condenser lens of the microscope (TXM) that has a CCD detector mounted on a long flight tube. Several diagnostics (diag.) will also be installed along the beamline.

## MISCELLANEOUS

The beamline will be opened for users when the following performances will be fulfilled: 1) 2D images of test patterns (as Siemens stars) to demonstrate 30 nm spatial resolution, and 2) sample temperature below 130 K to ensure preservation of vitreous ice.

A PIF-CSIC project between several groups of the CNB in Madrid (J.M. Carazo, C.O.S. Sorzano, R. Marabini & J.M. Valpuesta) and ICMA in Zaragoza (R. Navarro) has been awarded. The aim of this project is to implement the XMIPP software package used in electron microscopy (Sorzano *et al.* Journal of Structural Biology 148, 2004) for X-ray microscopy. The project will stand for 2 years and has started last September 2008

# BEAMLINE 11

## NON-CRYSTALLINE DIFFRACTION: NCD

*The NCD beamline has the following key elements: an in-vacuum undulator, a double crystal monochromator, collimating and focusing mirror optics an end station for SAXS experiments and a 2D detector.*

## OPTICS

The cryo-cooled double crystal monochromator awarded to ACCEL, Germany, last year is now approaching its factory acceptance test planned for early January 2009. Already the goniometer table and vacuum system has passed this milestone and the highly accurate silicon (111) crystals have been delivered to the supplier.

The monochromator system will remain in Gladbach until the cryo-cooler systems are ready for the factory acceptance tests. During these tests the NCD monochromator system will be used for demonstration to and training of Alba staff.

The mirror systems of the beam line were awarded earlier this year to IDT, UK. At the final design review that took place a few months ago particular attention was given to the accuracy and reproducibility of the alignment procedures. The mirrors are being polished at this moment whilst mechanical parts such as mirror benders, vacuum chamber and stable granite base block are already with the supplier. Installation of the mirror systems is scheduled to take place in two steps, the first one is planned for early March 2009. This will be the first installation of an optical component on the NCD beam line.

## BEAMLINE RADIATION HUTCHES

The radiation enclosures for BL11 were installed during the summer 2008 by the supplier, Calder,

UK, and were accepted by CELLS in September this year. Internally, there are manual cranes installed in both hutches that are rated for 1000 kg each. Both the outside and inside of these hutches have been painted (see figure 40: outboard view of beam line hutches) and figure 41 (inside experimental hutche).



Fig.40: Outboard hutche walls of BL11.



Fig.41: Inside the Experimental Hutche looking upstream.

### BEAM LINE INFRASTRUCTURES

The specifications for lighting, electrical and mechanical services as well as a complete layout for the routing of cable trays, liquid nitrogen lines, cooling water, gas supply of compressed air and nitrogen and vacuum exhaust pipe are ready for contractors to start work on the actual installations. Installations of these services are expected to be completed by middle of February 2009 and must allow all functions of the radiation enclosures to be fulfilled as well as meet the need of current and future users.

### END STATION LAYOUT

The detailed mechanical design of the components for the end station such as detector table, X-ray camera tube and more are the responsibility of the in-house engineers at CELLS (see figure 42). Sample

to detector distance can be adjusted in the range 0.3 to 7 m approximately. Some of these compo-

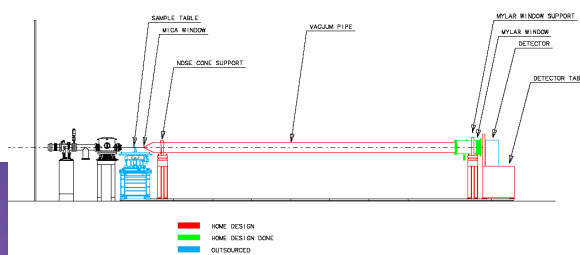

Fig. 42: Schematic layout of the beam line in the experimental hutche



Fig. 43: The mylar vacuum to air window mounted on the end tube of the X-ray camera.

nents have already been manufactured and tested such as the mylar vacuum to air interface window to be fitted at the end of the x-ray camera tube shown in figure 43.

### BEAM LINE CONTROL AND DATA ANALYSIS PACKAGES

The work to define beam line control system is in progress and will be commissioned sequentially in parallel with the installation of all beam line components starting with the arrival of the mechanics of the mirror systems early 2009.

A host of basic software programs for small angle scattering to be available on the beam line for data evaluation in 'real time' is being under consideration and may include at least the programs listed below:

| Program | Source               | Brief description   |
|---------|----------------------|---|
| XOTOKO  | Daresbury Laboratory | Non-crystalline diffraction and scattering processes software, 1D |
| BSL     | Daresbury Laboratory | Non-crystalline diffraction and scattering processes software, 2D |
| Fit2d   | ESRF                 | For viewing and processing of 2D data                             |
| CCP13   | Diamond Light Source | Programs for analysis of 1D SABS data                             |

For further information see: <http://www.cells.es/Beamlines/NCD>

# BEAMLINE 13

## MACROMOLECULAR CRYSTALLOGRAPHY: XALOC

*The key elements of the XALOC beamline are: an in-vacuum undulator, a cryogenically cooled double crystal monochromator, a Kirkpatrick-Baez focusing pair of mirrors and an end station consisting in a high precision diffractometer, an automatic sample exchanger for cryocooled samples and a 2D detector.*

The macromolecular crystallography (MX) beamline, XALOC, has to be able to solve structures at atomic resolution of biological macromolecules, which consist mainly of proteins or oligonucleotides, from their crystalline arrangement. The beamline has an intentionally generalist approach: it has to be able to tackle small crystals of a few tens of microns but at the same time it has to cope with large complexes involving many different macromolecules, which frequently crystallize in relatively large crystals. To design the beamline according to more specific users' needs, a meeting of Spanish users of MX beamlines was organized in October 2007. The meeting, which had 27 attendees from 13 different research groups, showed the progress of XALOC and provided a valuable feedback from the user community to define some practical requirements with especial emphasis in the design of the end-station. The main design parameters of the beamline are shown in Table 2.

After a careful design phase, XALOC is now progressing steadily at a high pace in three different directions in parallel: services, optics, and end-station (in order of installation). Two lead hatches, the first infrastructure elements, are currently being installed (December 2008). The two hatches, the optical and the experimental, will enclose the beamline optics and end-station, respectively. After them,

|                                  |   |
|----------------------------------|---|
| Photon source                    | In-vacuum undulator ( $K=1.6$ , $\lambda_U = 21.8$ mm)                        |
| Optics                           | Si(111) monochromator + two focusing mirrors (KB)                             |
| Wavelength (energy) range        | 0.57-2.1 Å (6 – 22 keV)   |
| Photon flux at sample            | $>2 \times 10^{12}$ ph/s in $50 \times 50 \mu\text{m}^2$                      |
| Wavelength (energy) resolution   | $D\lambda/\lambda = DE/E \sim 2 \cdot 10^{-4}$                                |
| Wavelength (energy) stability    | $D\lambda < 10^{-5}$ Å/hour ( $DE < 0.1$ eV/hour)                             |
| Beam size at sample (FWHM)       | Adjustable $50\text{-}200 \mu\text{m(H)} \times 10\text{-}200 \mu\text{m(V)}$ |
| Beam divergence at sample (FWHM) | $< 0.5 \times 0.1$ mrad (H×V)   |

**Table 2. General characteristics of XALOC. The KB (Kirkpatrick-Baez) system consists in two meridionally bent mirrors facing at perpendicular directions. Each mirror focuses in either horizontal or vertical direction.**

the installation will continue in early 2009 with the fluids pipes (gas and liquid nitrogen, compressed air, deionized water and air conditioning water), followed by the cable routing and the electrical and network systems.

Once the services have been set up, the optics is to be installed before summer 2009. All the main optical elements have already been manufactured and tested (See Figure 44). The tests included quality of optical surfaces, mechanical positioning of all axes (resolution, repeatability, hysteresis, range), vacuum compatibility, stability and vibrational behaviour.

The results have been excellent for the monochromator (1  $\mu\text{rad}$  resolution and 5  $\mu\text{rad}$  bidirectional repeatability in the Bragg axis, stability within 1  $\mu\text{rad}$  in 1 hour, no vibrational resonances below 100 Hz), as well as for the mirrors (less than 0.3  $\mu\text{rad}$  slope error for vertical focusing mirror and less than 0.5  $\mu\text{rad}$  for horizontally focusing mirror). In summary, the optical elements fulfill the speci-



**Fig.44: Main optical components of XALOC beamline. From left to right, monochromator, vertical focusing mirror (VFM) and horizontal focusing mirror (HFM).**

and are currently waiting to be finally installed at the beamline. The liquid nitrogen cooling system for the monochromator has also been procured, and is to be installed just after the optics.

The experimental station includes all the equipment needed to perform wavelength-selective and wavelength-independent experiments in an automated operation. The design is based in two granite positioning tables that are being developed in-house (See Figure 45). Both tables are designed to be adjustable in the micron/ $\mu$ rad range in all translations and rotations transversal to the beam axis to accommodate the x-ray beam onto very small crystals.

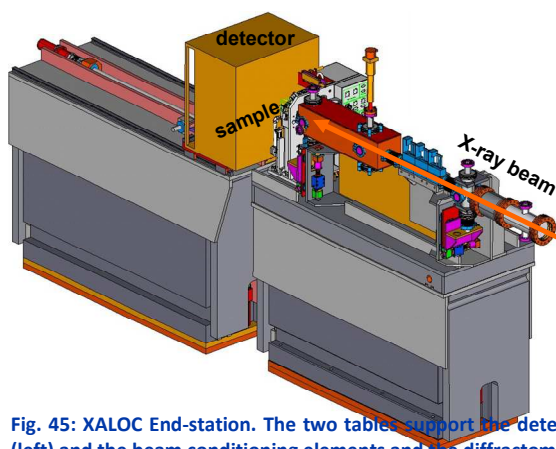

Fig. 45: XALOC End-station. The two tables support the detector (left) and the beam conditioning elements and the diffractometer with the sample (right).

A first table will support the beam conditioning elements (attenuators, slits, beam monitors and fast shutter) and the diffractometer. The conditioning elements will be procured during 2009, whereas the diffractometer, which is expected to be installed by the end 2009, will be similar to that used in many ESRF beamlines (MD2M microdiffractometer). The equipment of the end-station will also include a fluorescence detector, to set the photon wavelength at the absorption edge, and a removable 2-circle mini-kappa goniometer to better scan the reciprocal space of the diffraction pattern. A xyz-movable beamstop is also being developed in-house.

A separate table will allow adjusting the area detector vertically and longitudinally along the beam. The distance from sample to detector will range from 80 mm to 1.3 m. To help with the choice of the detector, as it is a key element of the beamline, we are currently gathering information and experience on different commercially available area detectors in the market.

The highly-flexible sample changer, to be installed at the beginning of 2010, will store crystal samples in cryogenic conditions and manipulate them automatically. Furthermore, it will also be able to operate on crystallization plates, thus allowing data collection in real time thus allowing data collection in real crystallization conditions.

Webpage: <http://www.cells.es/Beamlines/XALOC>

## BEAMLINE 22

### X RAY ABSORPTION SPECTROSCOPY: XAS

The beamline will be devoted to EXAFS and XANES and it will be equipped with a fast scanning monochromator, collimating and focusing optics and a X ray emission spectrometer. The main elements of the beamline optics have been produced, tested and accepted. The end-station is being designed. The central part of it, the x-ray emission spectrometer is at the detailed design stage. The infrastructure for in-situ catalysis studies is being built in collaboration with ITQ Valencia and it will be permanently available for all the users of the beamline.

### SUMMARY OF BEAMLINE OPTICS OPTICS

On 5.-7.11.2008 the factory acceptance tests were performed at FMB-Oxford (see the pictures below). The main part of the tests comprised resolution, repeatability and vibration measurements done with Renishaw interferometer. The tests revealed superior rigidity of the mirrors and the direct drive monochromator along with high accuracy of Bragg axis (<500 nrad) even at high rotation speed values. The delivery of the optics is planned for June 2009.

The remaining elements in the optics hutch: filters, fluorescence screen monitors, photon shutter and vacuum components will be purchased in the framework of 'standard elements' campaign.

### END STATION: X-RAY EMISSION SPECTROMETER (XES)

Considerable progress has been achieved in development of the spectrometer. The design of the vacuum vessel included finite element calculations on static vacuum load and vibration behavior. The crystal benders have attained a simple but robust design. The overall mechanical design is close to its final form. The diced analyzer crystals bent in one dimension statically and in the other dimension

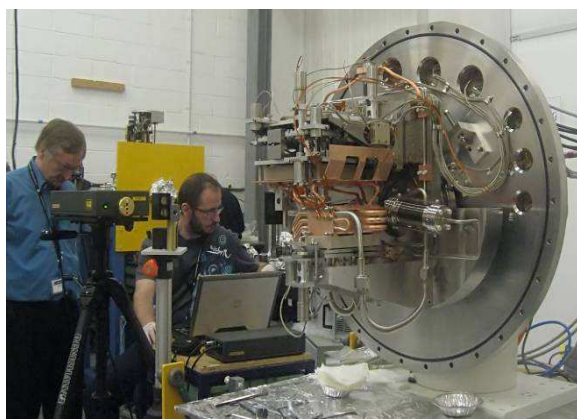
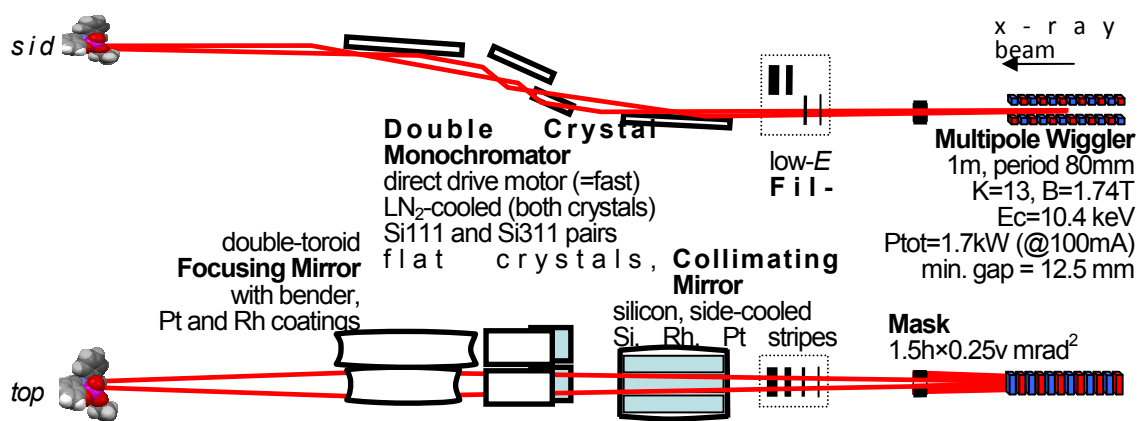

Figure 46 and 47: C. Ruget and J. Nicolas from ALBA are testing the mechanics of the monochromator (left) and collimating mirror (right).

dynamically are now under search for appropriate technology.

### END STATION: IN-SITU CELLS, GAS INFRASTRUCTURE

The ALBA XAS beamline is dedicating a great deal of its efforts to the prominent topic of catalysis. Action has been taken in this line in order to provide the Spanish as well as the international user community with a set-up that allows investigating *in situ* and with the aid of complementary spectroscopic techniques a wide range of solid-gas catalytic reactions at time resolution as low as a hundred of milliseconds benefiting from the high speed of the direct drive monochromator. When coupled to the innovative high resolution x-ray emission spectrometer, the absorption spectroscopy will become a modern research tool to study different catalytic reactions at very different conditions and from very different viewpoints.

This project is partially financed by the Spanish "Ministerio de Ciencia e Innovación" within the framework of ICTS named "Subprograma de diseño, viabilidad, acceso y mejoras de instalaciones científicas y técnicas singulares – Acciones Comple

mentarias". Funding has been awarded to ALBA (project ICTS-2008-18) to build *in situ* catalytic cells compatible with both XAS and MSPD beamlines, able to work at pressures up to 20 bar and temperatures ranging from liquid N<sub>2</sub> to 600°C, at least. This proposal is strengthened by the collaboration with the Instituto de Tecnología Química de Valencia (ITQ-CSIC) which provides its world-leading expertise in catalysis and takes care of the construction of the chemical reactors and their ancillary soft- and hardware control system.

This complete set-up will be fully integrated into the ALBA control system as well as into the pertinent beamlines so as to be readily available for the user community of ALBA. This venture will also include the infrastructure of gas equipment and piping and the adequate safety measures at the beamlines which these experiments imply. This infrastructure is currently being negotiated with different gas companies.

At present, the design of the cells and control system is already in progress and it is envisaged to be ready by mid 2009. The incorporation of complementary techniques is left for a later stage when new funding is available.

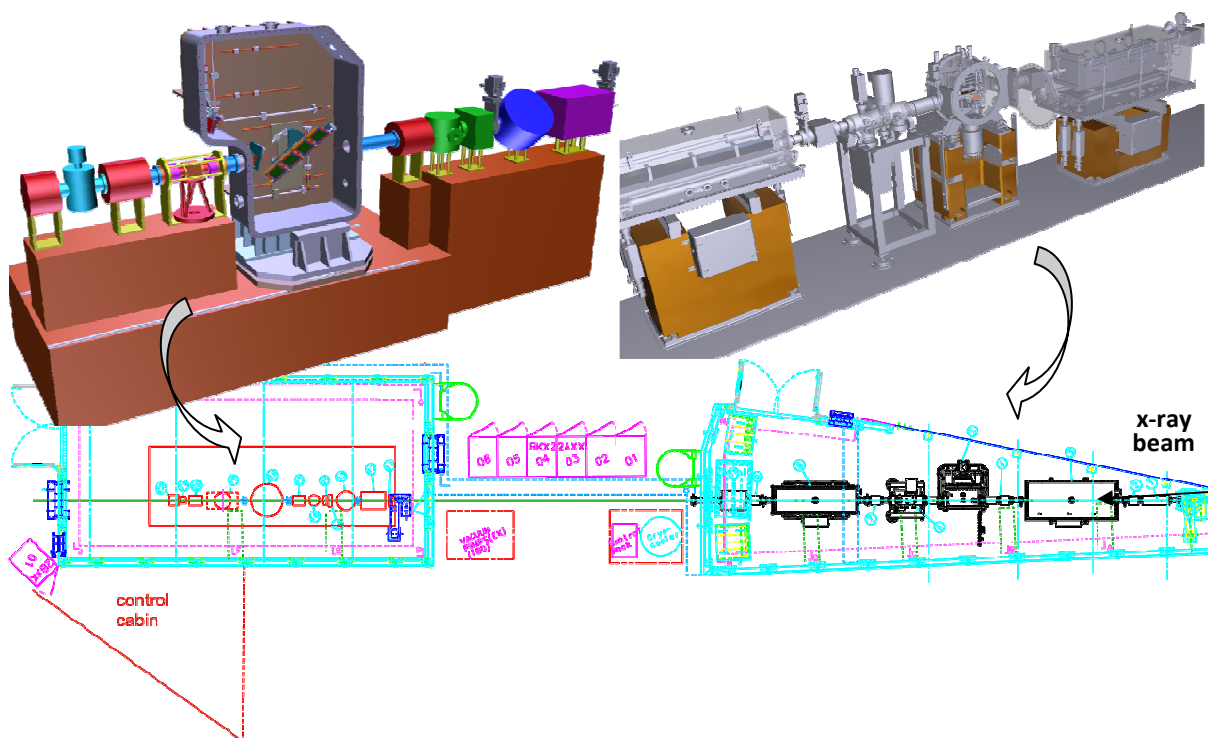

### SAFETY HUTCHES

The forthcoming months will be dedicated to the installation of the two safety hutches and general infrastructure: conventional piping, liquid N<sub>2</sub> piping cabling. The optics hutch is planned to be ready for receiving the optics in June 2009.

### CONTROL SOFTWARE

The concept of the beamline control software has been under development. The EXAFS data acquisition program will feature user-defined sample time and energy steps, editable multidimensional scans, flexible graphics capabilities etc.

## BEAMLINE 24.

### PHOTOEMISSION: CIRCE

*CIRCE is a soft x-ray beamline for advanced photoemission spectroscopy and microscopy experiments. The optics is designed for high photon flux, high photon energy resolution, and flexibility for adapting the trade-off between flux, energy resolution and high order suppression to specific experiments. Photons from 100 eV to 2000 eV with variable polarization are provided by an APPLE II undulator. The energy selection is done by a plane grating monochromator without entrance slit. Three exchangeable gratings are used to cover the full energy range. Downstream the grating chamber the x-rays are deflected alternatively to one out of two branches with dedicated exit slit, refocusing mirrors, and experimental station. One branch (PEEM) will*

*be devoted to spectro-microscopy with high spatial and energy resolution and the other one (NAPP) to photoemission spectroscopy at near ambient pressures.*

### BEAMLINE STATUS

Installation of the CIRCE infrastructure starts in December 2008 with the construction of the lead hutch for the first optical elements (see Fig. 48). The design for most of the beamline optics is finished and the manufacturing phase has started. The delivery and installation of the optical components will take place from May to July 2009. The undulator will be installed in July-August 2009, and the commissioning with synchrotron photon beam is planned to start in August 2010.

The PEEM experimental station is currently under design and will be installed in the experimental hall around the end of 2009. The tender process for the NAPP experimental station is currently open. The contract will be awarded in the beginning of 2009, in order to have the instrument delivered by the beginning of 2010.

### PEEM END STATION

The PhotoEmission Electron Microscope has an imaging electron energy analyzer, as well as an electron source and beam splitter for Low Energy Electron Microscopy and Diffraction capabilities. The main specifications are 10 nm lateral resolution in LEEM, 15 nm lateral resolution in PEEM, and 0.2 eV energy resolution. The experimental station

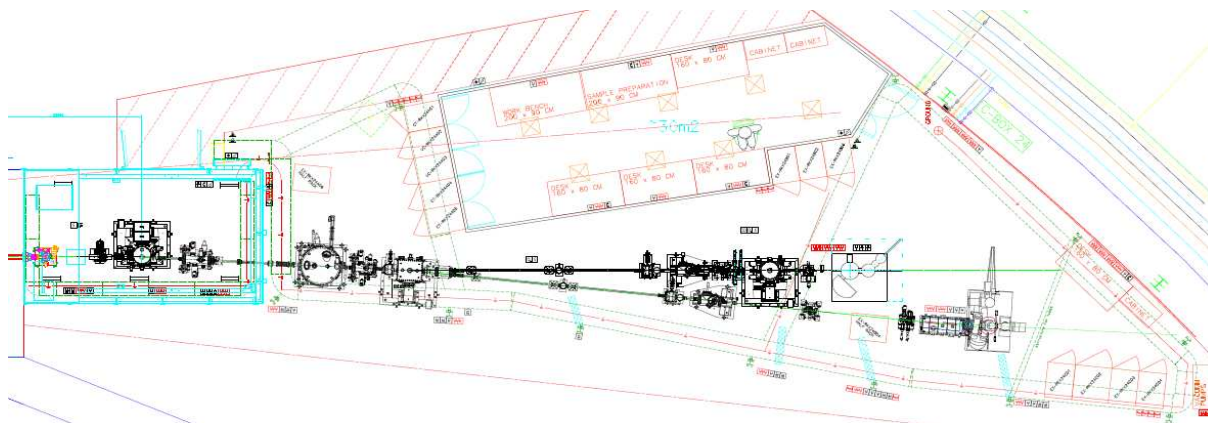

**Fig. 48: Planned layout of the CIRCE beamline space**

includes a surface preparation chamber and a load lock for fast introduction of samples from air. The microscope and the refocusing Kirkpatrick-Baez mirror pair will be installed on a common support structure in order to optimize the stability of the photon beam illumination (see Fig. 49).

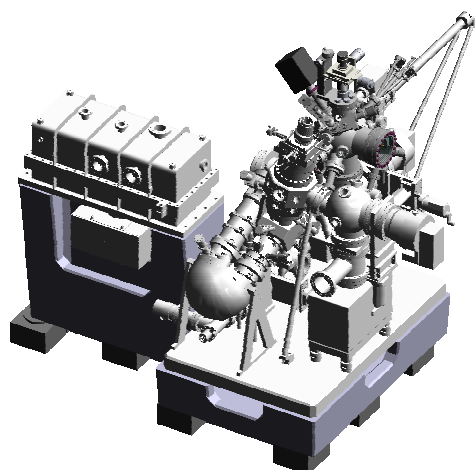

**Fig. 49: Kirkpatrick-Baez mirror chamber and PEEM station on common support structure.**

Energy filtered full-field imaging will enable accurate chemical mapping down to the core level shift detail. Small spot mode shall enable micro-spot spectroscopy or imaging of the reciprocal space (photoelectron diffraction, band mapping). The combination with the tunable polarization of the beamline - giving access to dichroic contrast - and the availability of LEEM and LEED, highly sensitive to the surface structure, permits a comprehensive approach to many problems, with fast switching between complementary experimental techniques. The applications range from surfaces, interfaces and thin film growth to nanoscale materials, micro-magnetism, model catalysts, and other heterogeneous systems where the interplay of structure, electronic, magnetic and chemical properties is of

interest.

### **NAPP END STATION**

The NAPP analyzer is a state-of-the-art high resolution photoelectron energy analyzer, with a modified entrance lens section including several differential pumping stages. This modification permits operating with sample environments up to several mbar, and, at the same time, minimizing the transmission losses throughout the operation pressure range. The electron energy resolution is comparable to standard state-of-the-art spectrometers, with a limit below 10 meV for the full kinetic energy range. The photon beam will enter the analysis chamber either through an ultrathin window or a differentially pumped aperture set up. Samples in the analysis chamber will be on a manipulator with 5 motion degrees of freedom, as well as sample cooling and heating capabilities. In order to be able to measure liquid or powdered samples, it will be possible to transfer samples from air to the analysis chamber in horizontal position. The station will permit attaching ancillary equipment such as a catalysis pre-treatment chamber or gas dosing lines.

The NAPP will be dedicated to experiments in the fields of heterogeneous catalysis, electrolytes, solid-liquid and liquid-liquid interfaces, fuel cells, surface science, etc. Both x-ray photoelectron spectroscopy and absorption experiments with variable polarization and sample geometry will be possible.

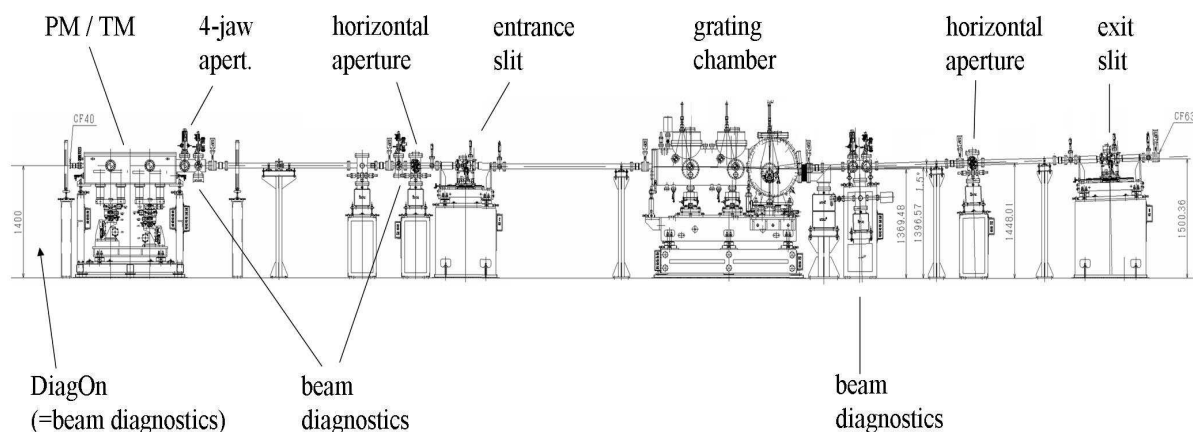

Fig. 50: Layout of BL29 XMCD at preliminary design state, including plane mirror/ toroidal mirror unit (PM/TM), 4-jaw aperture, horizontal aperture, entrance slit, grating chamber, beam diagnostic unit, horizontal aperture, and exit slit. Not shown in this picture: The DiagOn (=beam diagnostic unit) upstream the PM/TM unit, and the gas cell, Kirkpatrick-Baez refocusing unit, beam monitor, IO chamber, and the two experiments end-stations downstream the exit slit.

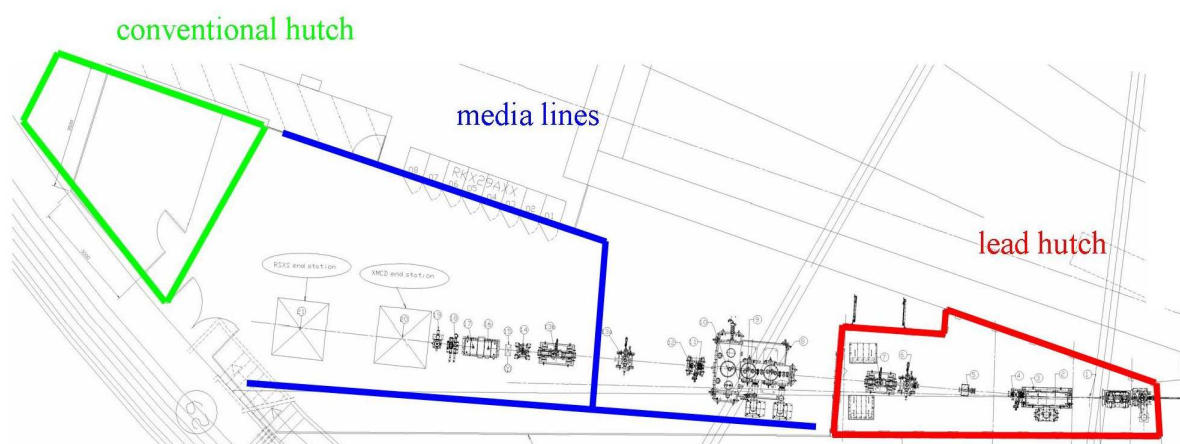

Fig. 51: Hall layout of BL29 XMCD. The conventional hutch accommodates the beamline control.

## BEAMLINE 29

### X RAY CIRCULAR MAGNETIC DICHRUISM . XMCD

*The XMCD beamline will consist in a Helical undulator of the Apple II type, focusing mirror optics, a grating monochromator and two end stations: one equipped with a cryomagnet for XMCD and a soft x ray scattering chamber for resonant diffraction experiments. In addition, a STM mounted in a ancillary chamber between both end stations will be available for surface morphology characterization. The STM is a result of a collaboration with the Institut Catala de Nanociencia (ICN).*

The supply of the optical components of the beamline has been contracted in the fall 2008. Contracts were awarded to Toyama for the delivery of the

beamline backbone, the grating chamber, and the gratings (subcontracted to Carl Zeiss), and to SESO for the delivery of the mirrors. The preliminary design of the beamline is now accomplished, and the detailed design is under review. The original plan to install the beamline inside a conventional hutch was altered in favor of a smaller hutch which accommodates the beamline control. In the new layout, the beamline will be installed in the open experiments hall with the media lines guided along the beamline on freestanding pillars. With this approach we expect to improve the thermal stability of the beamline optical components.

The design of the first experimental end-station, dedicated to dichroic experiments in absorption, is based on a He cryostat (<2K) with superconducting magnet ( $\pm 7T$ ). A call for tender for this chamber has been launched in summer 2008, and offers were received in fall 2008. The design of the second experimental



End- station, dedicated to resonant diffraction experiments, is based on a two circle diffractometer ( $\Theta/2\Theta$ ) with additional access to Chi (about  $\pm 2^\circ$ ), a He cooled sample holder ( $<2K$ ), and a moderate magnetic field ( $\pm 0.1T$ ). This equipment (UHV chamber and two fold differentially pumped rotary feedthrough) will be realized in the frame of an in-house project. In addition, a preparation chamber for in-situ preparation and characterization (LEED, STM) has been designed and built in collaboration with the ICN and partially funded by the Ministerio de Educacion y Ciencia under grant CAC-2007-34. At present, efforts are primarily concentrated on the design, procurement, and installation of the infrastructure and hutches. In particular this includes the optics (safety) hutch, the experiments hutch, and the media lines (power cables, signal cables, fluid lines) which should be ready prior to the installation of the beamline.

## OPTICS LABORATORY

The activities of the Laboratory of Optics are divided into two main areas: optics metrology and mechanics metrology. The former consists on the characterization of the optical surfaces of the beamlines, as part of their reception tests program, as well as during the commissioning and maintenance. The latter is the characterization of the motion performances of the beamline components.

The Laboratory of Optics is temporarily located in the University campus until the definitive spaces for the laboratory in the main building of the Alba facility are available. In the Alba building, the laboratory occupies 125m<sup>2</sup> close to the experimental hall. This area is distributed in three main rooms: a Class 10.000 clean room, a regular laboratory, plus a reception room. All the spaces are over-pressurized with respect to the experimental hall, and have enhanced thermal isolation from the neighbor spaces in order to obtain clean environment and high temperature stability. Among the three spaces, the best temperature stability is reached in the clean room, where the optical metrology will take place. In addition, local enclosures are foreseen for some instruments of the laboratory (LTP and Fizeau interferometer), in order to obtain homogeneous, silent and constant environment conditions for the most delicate measurements.

### OPTICS METROLOGY

The main instruments for optics metrology are a long trace profilometer (LTP) and 4 inch aperture

Fizeau interferometer with adjustable spatial coherence (shown in Figure 52). These instruments will be used to measure the figure and slope errors of the mirrors and gratings for the beamlines. In the future, the laboratory equipment will be upgraded with a Mirau-interferometer and an atomic force microscope. These instruments will be used to characterize the roughness and the micro-roughness of the optical surfaces.

The LTP is an instrument that measures the slope



Fig.52: Picture of the Fizeau interferometer that will be used to measure the slope error of the mirrors of the first beamlines at Alba.

profile of the mirrors by measuring the deflection induced on a probe beam, which is scanned along the mirror surface. The LTP of Alba will integrate two optical heads be mounted on a high accuracy scanning bench. The system is currently being manufactured and will be delivered to the laboratory in April '09. Due to the late delivery and the long commissioning time foreseen for the LTP, many of the mirrors for the phase 1 beamlines will be characterized using the Fizeau interferometer. For that, 2 flats and 5 different convex spheres reference mirrors have been purchased. With them, 90% of the mirrors can be characterized in the usual double bounce setup. The rest of the mirrors will be measured by combining the double bounce setup with stitching techniques.

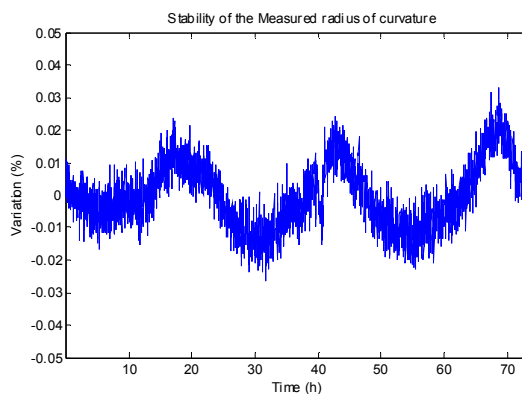

Figure 53. Relative variation of the radius of curvature measured from a spherical mirror during 72 hours.

The Fizeau interferometer is being commissioned in the temporary laboratory, in the facilities that Alba has in the University. The laboratory is over-pressurized with filtered and dry air, and the temperature is stable within  $\pm 0.3^{\circ}\text{C}$  in 24h. The limiting factor for the temperature stability is the poor isolation of the laboratory.

In the present conditions, the interferometer is capable of measuring the mirror profile with a repeatability of 0.4nm RMS point to point. This is limited by the noise of the CCD, and can be easily improved by averaging. More significant is the stability of the measure of the radius of curvature of mirrors provided by the interferometer, which remains within 0.02% during several days (see Figure 53) of continuous measurements – one dataset each 60 seconds. This variation is correlated to temperature, and is expected to be more stable in the definitive laboratory.

In order to improve the accuracy of the measurements, which is limited by the errors of the reference surfaces, the lateral shearing technique has been adapted for the Fizeau interferometer. This consists on measuring the sample mirror at different positions, and then reconstructing the wavefront and the mirror surface from the differences between the different acquisitions. In this case the error of the references can be completely removed. Then the accuracy of the measurement is mainly limited by the uncertainty in the motion of the mirror between measurements: positioning errors, and parasitic angles during the translation.

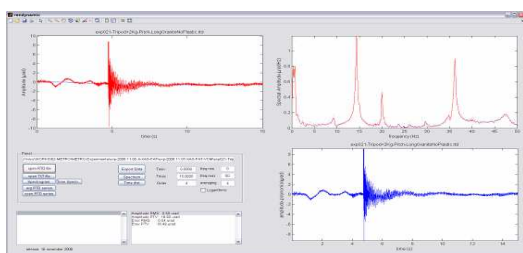

Fig.54: Screen capture of the RenDynamic application developed

Algorithms developed for estimating and compensating these errors are being tested. With them the accuracy of the surface reconstruction is expected to be in the order of the few nanometers.

### MECHANICS METROLOGY

Another task of the Laboratory of Optics is to provide the precision metrology for characterizing the mechanical performance of the beamline during their acceptance tests and commissioning. For this task, the laboratory counts with several instruments, being the linear interferometer the most used one, given its versatility to measure angles

and linear distances, with high resolution, accuracy and sampling rate.

The raw data obtained by the interferometer data is processed with RenDynamic (see screenshot in Figure 54), an application written in Alba to improve the processing provided by the interferometer: The main features of the application are the selection of time windows and the removal of polynomial terms (drifts), so as to obtain the resonance spectra during vibration experiments. Other features available are frequency filtering and synchronization with the encoder record. These are very useful features for performing resolution and accuracy tests.

An example of resonance spectra obtained with RenDynamic is given in Figure 55. It corresponds to a study of the standard floor link for optical components at Alba, which consists in gluing a steel plate below the support of the optical component (in this case made on granite). However, since the flatness of the steel plate and the granite is limited, some manufacturers propose to compensate the unevenness with a plastic layer in between the two surfaces. At the same time, the pads act as dampers for higher frequencies. In the case studied in Figure 54, the spectral response of the system was compared with and without the plastic pads installed (in blue and red, respectively). It can be seen that the plastic pads introduce additional resonances, which mean that the system presents additional unstabilities with respect to the floor.

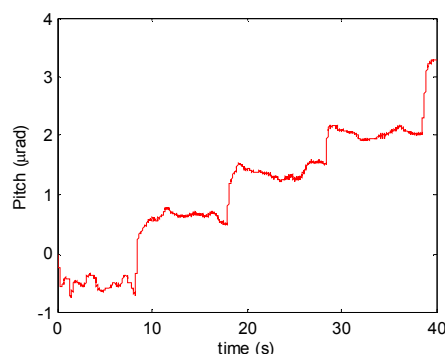

Fig. 55: Measure of the pitch resolution of a mirror system for one of the beamlines at ALBA. Each step, of one microradian, corresponds to 14 motor fullsteps.

The first components for beamlines have already been tested using Alba’s metrology capabilities. An example is given in Figure 55. It shows the test of the pitch resolution for a mirror system. Each step in the plot is  $1\mu\text{rad}$  wide, and it corresponds to 14 motor fullsteps. In this case, the motor is controlled by an IcePAP, working in close loop mode. One can observe that the system reaches the target position at null speed, what allows a fast settling of the system on the target position.

# FIRST MEETING OF THE ALBA COUNCIL ON DECEMBER 15<sup>TH</sup> AT THE ALBA SITE

On December 15th a meeting of the council of ALBA took place to follow the progress of the project and to prepare the funding of the exploitation phase. The meeting was held in a brand new meeting room at the first floor of the ALBA building as shown in the picture below.

After the Council meeting, a visit took place through the facility together with journalists and guests from industrial companies.



**Fig. 56: First Council meeting at the ALBA building. The members visible on the photograph are: At the center Ms. Cristina Garmendia and Mr. Josep Huguet ministers of Research of the Central and Generalitat Administrations respectively. At the right hand side of Ms. Garmendia, Mr. R. Pascual, president of the Consortium, Mr. J. M. Fernandez de Labastida, General Secretary of Scientific and Technologic Politics and Mr. J.J. Moreno General Director of Planning and Organization. At the left hand side of Mr. Huguet, Mr. J. Bordas, Director of ALBA, Mr. R. Moreno. General Director of Research and Mr. L. Ferrer, Rector of the Autonomous University of Barcelona.**



Fig. 57: Members of the Council during the visit .



Fig. 58. The Head of the Accelerator Division , D. Einfeld, is showing the LINAC to the Council members.