



ACTIVITY REPORT 2018

A bright year of discoveries

© ALBA Synchrotron. All rights reserved.

ALBA Synchrotron

Carrer de la Llum 2-26

08290 Cerdanyola del Vallès (Barcelona)

Spain

Tel. +34 93 592 4300

Editors: Salvador Ferrer and Ana Belén Martínez

Graphic design: Lucas Wainer

Printing: Artgraf

FOREWORD



A year of exciting scientific results, smooth operation, enriching collaborations, innovation, outreach and training activities has gone by at ALBA. In this report you will find a hint of life in 2018 at our facility, where the first priority is Safety.

A key figure of a light source is the beamline portfolio. Following the trend of the last few years, we got the approval for starting the construction of a new beamline: FaXToR will become the 12th ALBA beamline, a hard X-ray tomography instrument that will complement our imaging capabilities, now represented by the soft X-ray Cryo-microscope of MISTRAL.

The 2017-2020 Strategy Plan, presented to our stakeholders as is required for a member of the Spanish map of so-called *Singular Scientific and Technical Infrastructures* (ICTS), was approved after its evaluation by the Singular Infrastructures Assessment Committee (CAIS). This plan lays the basis for the present and future investments in new beamlines and upgrades of the existing instrumentation.

LEAPS, the League of European Accelerator-based Photon Sources, is now a reality. We delivered the Strategy 2030 to the European Commission and to the scientific community, highlighting what our priorities will be, based on the vision of helping to solve society's challenges. The first Plenary Meeting was held in Hamburg in November, gathering scientists, experts in all light sources techniques, European Commission and national funding agencies representatives. Adding up LEAPS members potential will boost the capacities of each individual facility for the benefit of the European research and innovation landscape.

Caterina Biscari
Director



ALBA, A SCIENTIFIC BOOSTER FOR SPANISH SCIENCE

The ALBA Synchrotron is the **largest scientific infrastructure in Spain**, providing cutting-edge synchrotron-based techniques to **more than 2,000 researchers every year**. Based on a complex of electron accelerators, ALBA produces extremely bright beams to analyse and understand the properties of matter with photon energies ranging from infrared to hard X-rays.

ALBA provides **solutions to current societal challenges**, ranging from health to energy production and storage, from environmental problems to advances in communication technologies, and from understanding our cultural heritage to preserving it.

BEAMLINES UNDER CONSTRUCTION

As of 2018 there are two beamlines under construction (LOREA and NOTOS) and one in the design phase (XAIRA). Additionally, the Governing Council of ALBA has approved the construction of a 4th beamline (FAXTOR).

Great progress was made in the construction of the LOREA beamline this year. The four gratings of the monochromator were received and tested. Several kick-off meetings were held with the companies involved in the backbone (the opto-mechanical system of the whole beamline). A detailed design of the monochromator (in-house development) was finished and the user hutch and the pillars of the infrastructure were installed. Finally, the endstation entered the design phase with the goal of opening the beamline to official users in June 2020.

NOTOS activities have been mainly related to its design. The Optical Design Report was approved and all the operating modes were determined suitable for absorption spectroscopy, powder diffraction and metrology activities. The specifications of the monochromator and focusing mirror have been fully defined and a call for tenders was published for their procurement. The experimental and optical hutches (radiation shield) have also been designed and their construction contracts have been awarded. The contract for the supply of the front end was also awarded and its DDR approved. Since a significant part of the equipment of NOTOS comes from the dismantling of the Spanish beamline Spline (ESRF), several visits were necessary to evaluate the integration of the coming elements in the new beamline and organize their transfer to ALBA.

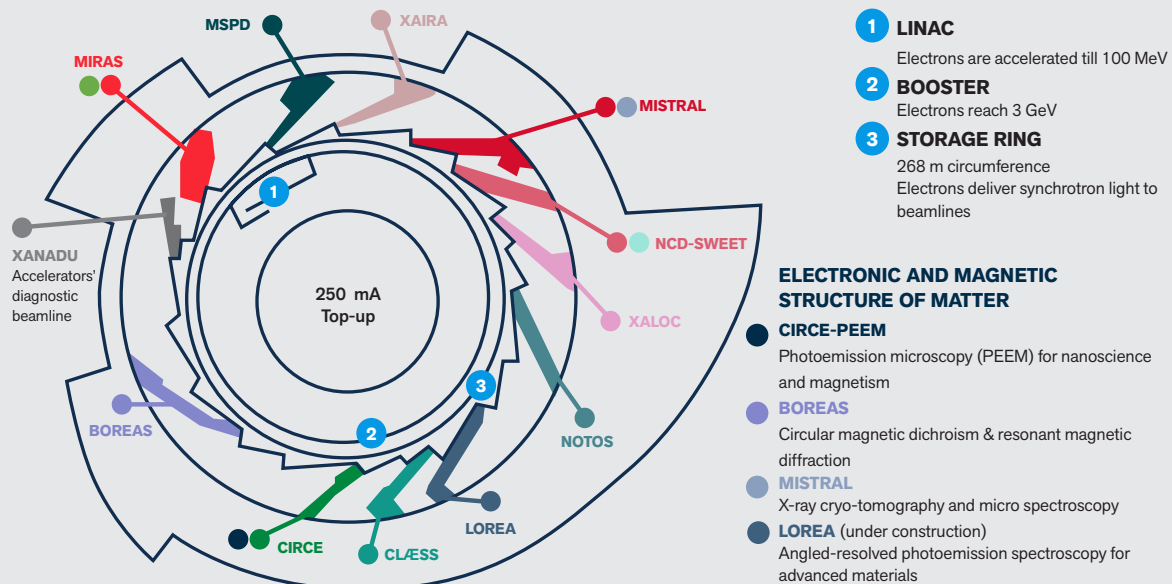

LIFE SCIENCES AND SOFT CONDENSED MATTER

- NCD-SWEET**
Small & high-angle X-ray scattering/diffraction
- XALOC**
X-ray diffraction for macromolecular crystallography
- XAIRA (under construction)**
X-ray microdiffraction for macromolecular crystallography
- MIRAS**
Infrared microspectroscopy
- MISTRAL**
X-ray cryo-tomography and micro spectroscopy

CHEMISTRY AND MATERIALS SCIENCE

- MSPD**
High-resolution & high-pressure powder diffraction
- NOTOS (under construction)**
X-ray absorption & powder diffraction
- CLÆSS**
X-ray absorption & emission spectroscopy for catalysis, environment
- NCD-SWEET**
Small & high-angle X-ray scattering/diffraction
- MIRAS**
Infrared microspectroscopy
- CIRCE-NAPP**
Near-ambient-pressure photoemission (NAPP) for surface chemistry

WORKING FOR A BRIGHT FUTURE

ALBA published the last Strategy Plan for the period 2017-2020, which was positively evaluated by the Spanish Ministry of Science, Innovation and Universities in November 2018. The document has two different parts: an analysis of the performance of the facility in the previous period and a strategy plan with objectives, strategies and resources for the coming years. The main objectives for this period are: prioritising scientific research in drug design and biological processes involving drugs, magnetic nanomaterials, catalysis and environmental sciences and energy-related materials, promoting technological developments as well as technology transfer, contributing to the education for future researchers, expanding

international activities with new collaborations and preparing a long-term strategy for the facility.

ALBA has been actively involved in the LEAPS Initiative, a strategic consortium of 19 European light source facilities aimed at promoting scientific collaboration, integration and competitiveness. In 2018, the LEAPS Strategy 2030 was submitted to European authorities. The document highlighted how smart specialisation, closer cooperation, better engagement with industry and working together with the user communities will improve the scientific services of all the facilities. On 12-13 November 2018, the first LEAPS plenary meeting was held to present pilot projects to meet these objectives.

GOVERNING BODIES

ALBA is funded in equal parts by the Spanish and Catalan governments. The composition of the governance in 2018 is:

GOVERNING COUNCIL

Chair: M^a Àngels Chacón i Feixas, Minister of Business and Knowledge (GENCAT, Catalan gov.)

Vice-Chair: Pedro Duque Duque, Minister of Science, Innovation and Universities (MINCIU, Spanish gov.)

Members

- Rafael Rodrigo Montero, Secretary-General for Science Policy Coordination, MINCIU
- José Ignacio Doncel Morales, Deputy director for Singular Scientific and Technical Infrastructures, MINCIU
- Rosa Menéndez López, President of the Spanish National Research Council (CSIC)
- Francesc Xavier Grau i Vidal, Secretary for Universities and Research, GENCAT
- Joan Gómez i Pallarès, Director-General for Research, GENCAT
- Margarita Arboix Arzo, Rector of the Universitat Autònoma de Barcelona (UAB)

Secretary: Berta Bernad Sorjús, Lawyer of the Catalan government, GENCAT

Vice-Secretary: Severo Bueno de Sitjar de Togores, State lawyer, MINCIU

Guest: Caterina Biscari, Director of ALBA

EXECUTIVE COMMISSION

Chair: Rafael Rodrigo Montero, Secretary-General for Science Policy Coordination, MINCIU

Members:

- Francesc Xavier Grau i Vidal, Secretary for Universities and Research, GENCAT
- José Ignacio Doncel Morales, Deputy director for Singular Scientific and Technical Infrastructures, MINCIU
- Joan Gómez i Pallarès, Director-General for Research, GENCAT

Secretary: Severo Bueno de Sitjar de Togores, State lawyer, MINCIU

Vice-Secretary: Berta Bernad Sorjús, Lawyer of Catalan government, GENCAT

Guest: Caterina Biscari, Director of ALBA

SCIENTIFIC ADVISORY COMMITTEE

Board of internationally renowned experts in the field of synchrotron radiation, who participate in the strategic scientific direction of the ALBA synchrotron with the aim of ensuring the quality and relevance of the research performed and developed at ALBA.

Chair: Ian Robinson, Full permanent professor of the London Centre for Nanotechnology & X-Ray Scattering Group Leader at Brookhaven National Laboratory in New York (USA)

Members:

- Gwyndaf Evans, Principal Beamline Scientist for VMXm at Diamond Light Source (UK)
- Reinhard Brinkmann, Leading Scientist in the DESY Accelerator Division. Hamburg (Germany)
- Valerie Briois, ROCK beamline manager at Soleil Synchrotron (France)
- Tiberio Ezquerro Sanz, Head of Soft and Polymeric Matter Group at Instituto de Estructura de la Materia-CSIC (Spain)
- Amina Taleb-Ibrahimi, Director for Matter Sciences at Soleil Synchrotron, Gif-sur-Yvette (France)
- Pedro Fernandes-Tavares, Project Leader for the Storage Rings at Max-IV Laboratory. Lund (Sweden)
- Marco Stampanoni, Paul Scherrer Institut & Swiss Federal Institute of Technology Zürich (Switzerland).
- Carlo Carbone, Research Director at Consiglio Nazionale delle Ricerche, Istituto di Struttura della Materia (Italia)
- Oliver Seeck, Group leader of the "PETRA III experiments" group at DESY in Hamburg (Germany).

KEY FIGURES IN 2018

A reliable service for our users

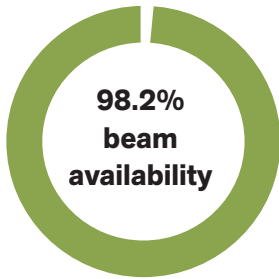

5,912 operation hours

4,680 hours for beamlines

91.7 hours Mean Time Between Failures

1.67 hours Mean Time To Repair



430 Submitted Proposals
256 Granted Proposals

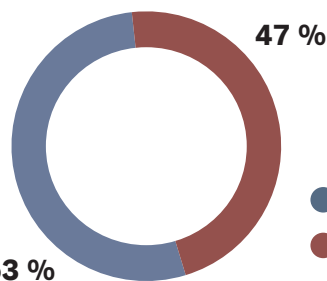
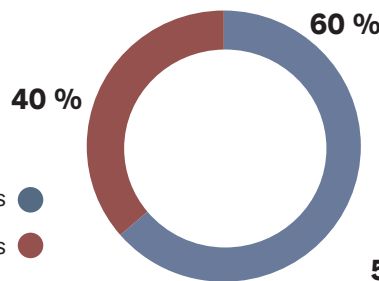

5,293 Requested Shifts
2,808 Awarded Shifts

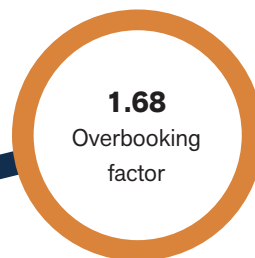
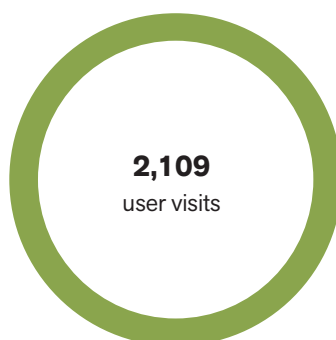
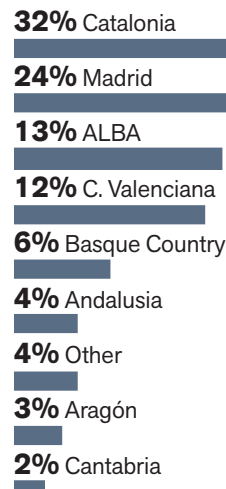
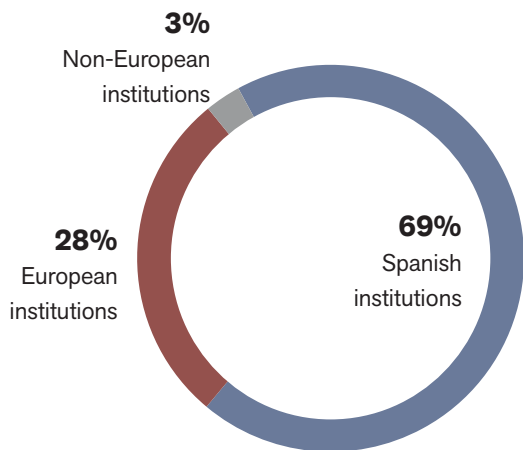

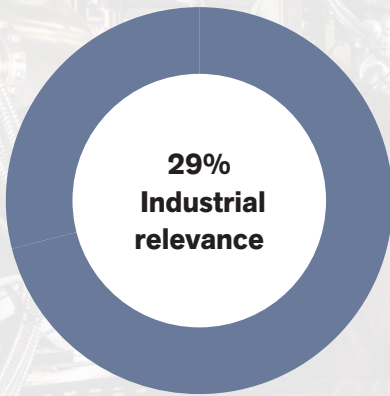
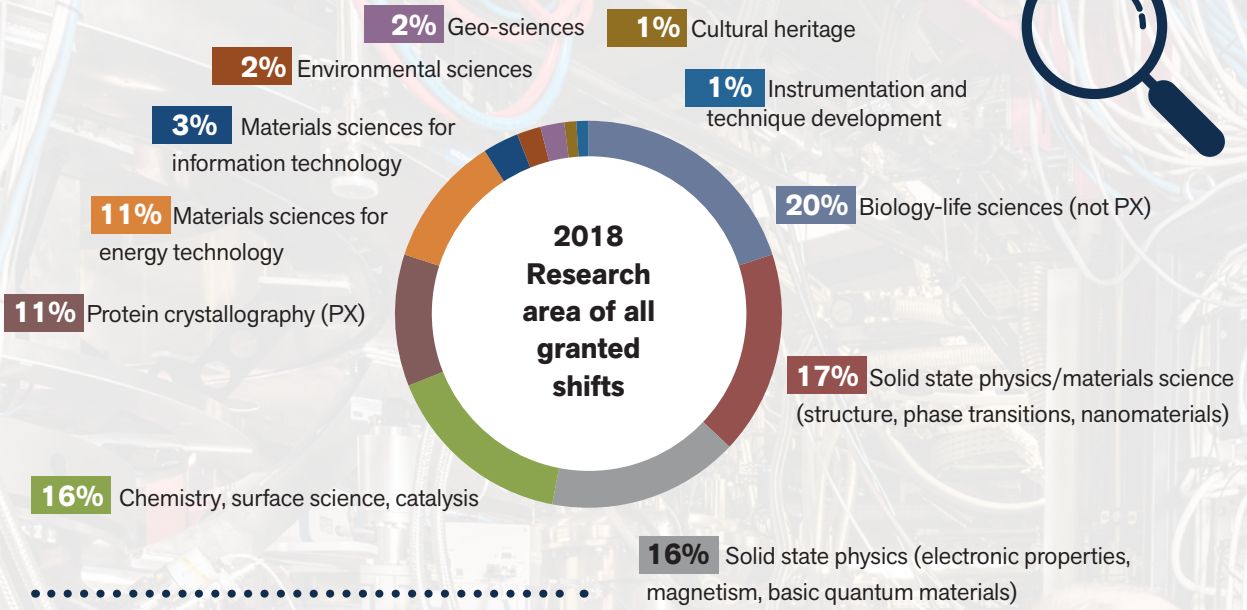

277 peer-reviewed publications

225 beamtime publications

50 beamtime publications impact factor > 7.0



212 Staff Members

22% Non-Spanish nationalities

27% Women

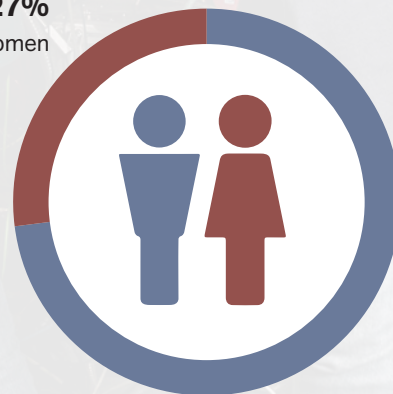



JANUARY

Award for safety procedures

ALBA was recognised by the Asepeyo Awards as featuring the best prevention practices with the implementation of an integrated control system for the experiments carried out at the facility.



FEBRUARY

ALBA at the Big Science Business Forum

ALBA's capabilities and development plans were presented in the event where the world's largest high-tech research facilities and companies gathered for the first time.



MARCH

Enhancing the visibility of women in science

Caterina Biscari, director of ALBA, was recognised as Woman Scientist 2018 by the Woman's Week Foundation for her leading role managing the biggest scientific infrastructure in Spain.



APRIL

ALBA opens a liquid helium recovery plant

This installation, built in collaboration with ICN2, is unique in Catalonia and allows recycling 80% of the liquid helium consumed in the facility for operating the superconducting magnets and for experiments at ultra-low temperature.



MAY

Sharing our passion for science with the general public

The 2018 ALBA Open Day welcomed more than 2,300 visitors who enjoyed visiting our facilities and discovering how ALBA works and the impact of our research in their lives.

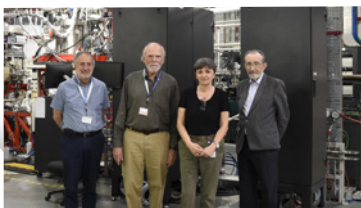

JUNE

Nobel Prize Barry C. Barish at ALBA

The Nobel Laureate in Physics for his role in the detection of gravitational waves had the opportunity to visit the experimental hall and talk to different researchers who were performing their experiments at the beamlines.

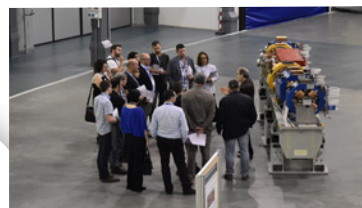

JUNE

Synchrotron light applications for metallurgy and surfaces treatment

More than 50 participants attended the workshop addressed to companies working in materials science and technology and exploitation of metals.

2018 IN ALBA



JULY

The future of European particle accelerators, under discussion at ALBA

On 19 and 20 July, the ALBA Synchrotron was honoured to host the 102nd Plenary European Committee for Future Accelerators (ECFA) meeting, with the participation of 70 researchers.



AUGUST

Upgrade of the Booster RF Amplifier

During the summer shutdown, the IOT amplifier of the Booster based on vacuum tube technology was replaced by a Solid State Power Amplifier of 50kW (SSPA), developed by the Spanish company BTesa and co-funded with ERDF funds.



SEPTEMBER

New educational project for primary school students

Misión ALBA was launched for the first time to promote scientific vocations among young students and to offer teachers simple resources to work with science in classroom.



OCTOBER

Green light for the 12th beamline

The Governing Council approved the construction of a new beamline, FAXTOR, devoted to X-ray tomography.



NOVEMBER

First Plenary Meeting of the LEAPS initiative

More than 150 representatives from the 16 member facilities discussed about the global challenges and proposed 13 pilot research projects to keep advancing in the collaboration.



DECEMBER

Spreading the news at the hospitals

In collaboration with UAB researcher Manel Sabés, several beamline scientists visited different hospitals around Spain to show how synchrotron light can help medical diagnose and analysis.

Life Sciences and Soft Condensed Matter

Judith Juanhuix, Head of the Life Sciences and Soft Condensed Matter section (Experiments Division).

This section includes a variety of beamlines to cope with a manifold of samples inspected at spatial resolutions spanning several orders of magnitude. Samples range from single-type proteins in an ordered repeat forming a crystal, solved at a near-atomic resolution, up to whole tissues probed at a micrometric scale.

The beamlines catering such different studies are diverse. In the hard X-ray range, the section includes the operating macromolecular crystallography beamline XALOC and the non-crystalline scattering/diffraction beamline NCD-SWEET. The section also comprises the full-field transmission soft X-ray microscopy beamline MISTRAL, devoted to cryo micro tomography and the spectroscopy and microscopy infrared beamline MIRAS. In addition, the design and construction of the microfocus macromolecular crystallography beamline XAIRA is progressing steadily. XAIRA will be equipped with a multilayer monochromator, ideal for serial crystallography techniques, which will produce the brightest flux in the hard X-ray range at ALBA.

Still, the most remarkable progress in the section is the approval and funding by the governing bodies of the new hard X-ray tomography and radioscopy beamline FAXTOR. After the appointment of the beamline leader, the first technical feasibility and design studies, especially concerning the photon source, is ongoing. It is planned that the beamline will finish construction in 2023, thereafter receiving external scientific groups.

The beamlines of the section are well supported by close-by biological laboratories, which have been expanded to a total area of 230 m². A new, full-equipped mammalian cell culture lab with biosafety level 2 capabilities has been put into operation. An automatic dispenser for protein crystallization compatible with LCP techniques is now available for academic and industrial usage upon demand.

Operationally the beamlines in the section received a large number of national and international proposals. It is especially relevant the increase of the number of experiment proposals for the NCD-SWEET beamline, in response to the major upgrade of the beamline, which includes the implementation of microfocus capabilities and the full operation of the GISAXS station for polymer science. During 2018 a total number of 189 experiments were awarded beamtime, 14 of which being industrial, leading to a total of 107 publications, some of them in the materials science field involving MIRAS, MISTRAL and NCD-SWEET. Indeed the demand for beamtime at the operating beamlines was much higher, and more than half of the requested beamtime could not be allocated.

Concerning scientific activities, the section beamlines and the scientific staff are involved in several national and international collaborations, which include three ongoing co-directed PhD programs, aiming at developing in-house research, five awarded competitive grants and four agreements, established in national and international context.

New insights about cholesterol crystals formation

The structure of cholesterol crystals in atherosclerotic plaques was determined, providing insight on the cellular crystal cholesterol growth mechanisms.

Atherosclerosis causes heart attack and stroke and is a major fatal disease in the Western world. The formation of atherosclerotic plaques in the blood vessel walls is the result of low density lipids (LDL) particle uptake, and consequently of cholesterol accumulation in macrophage cells. Excess cholesterol accumulation eventually results in cholesterol crystal deposition, the hallmark of mature atheromas.

A collaboration team involving the Weizmann Institute of Science, MISTRAL beamline at ALBA and the University of Milano investigated the formation of cholesterol crystals in macrophage cells using correlative cryo-soft X-ray tomography (cryo-SXT) and stochastic optical reconstruction microscopy (STORM) technique. In the initial accumulation stages, small quadrilateral crystal plates associated with the cell plasma membrane are formed. These plates, which may subsequently assemble into large aggregates, match crystals of the commonly observed cholesterol monohydrate triclinic structure. Large rod-like cholesterol crystals form at a later stage in intracellular locations. Using cryo-transmission electron microscopy (cryo-TEM) and cryo-electron diffraction (cryo-ED), the researchers showed that the structure of the large elongated rods corresponds to that of monoclinic cholesterol monohydrate, a recently determined polymorph of the triclinic crystal structure. These monoclinic crystals form an unusual hollow cylinder or helical architecture, which is preserved in the mature rod-like crystals. The rod-like morphology is akin to that observed in crystals isolated from atheromas. It is suggested that the crystals in the atherosclerotic plaques preserve in their morphology the memory of the structure in which they were formed. The identification of the polymorph structure, besides explaining the different crystal morphologies, may serve to elucidate mechanisms of cholesterol segregation and precipitation in atherosclerotic plaques. Cholesterol crystal rods and plates are the evidence of developed atherosclerotic plaques and are associated with plaque rupture and thrombus formation. The structural

differences between the two observed polymorphs and their relation to crystal morphology described in this research may open the path for an investigation, at the molecular level, of cholesterol nucleation and growth. Once the factors that favor the formation of the monoclinic polymorph are understood, mechanistic information on the cellular pathways of cholesterol crystal formation may become evident.

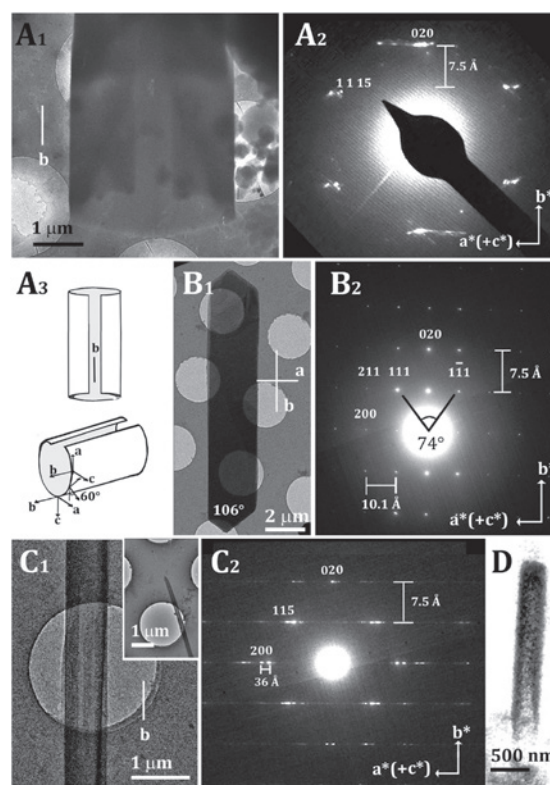

Figure 1: Cryo-TEM and ED of cholesterol crystals grown in cells and on lipid bilayers. (A) Cryo-TEM image and diffraction of a cholesterol crystal grown in a cell following incubation with acLDL for 48 h. (A1) Cryo-TEM image. (A2) Cryo-ED pattern. The two blurred spots on the central axis correspond to 020 and 02'0. The 1,1,15 reflection implies an angle of 60° between the c axis and the incident beam, suggesting an elliptic cross section of the tube (A3). (A3) Proposed open-tube model of the crystal in A1 and A2. The direction of the b axis remains constant, whereas the direction of the a axis rotates with the tube curvature. (B) Faceted monoclinic cholesterol monohydrate crystal grown on a supported lipid bilayer composed of cholesterol/DPPC/POPC = 42/18/40 mol%, externally supplemented with cholesterol. (B1) Cryo-TEM image. (B2) Cryo-ED pattern. (C) Tubular cholesterol crystal grown on a supported lipid bilayer as in B. (C1) Cryo-TEM image. (C1, Inset) The same crystal at low magnification. (C2) Cryo-ED pattern. (D) Volume rendering of the segmented cryo-SXT data of a crystal from one cell, showing tubular morphology.

REFERENCE:

Two polymorphic cholesterol monohydrate crystal structures form in macrophage culture models of atherosclerosis **PNAS** (2018) 115 (30) 7662-7669 DOI: 10.1073/pnas.1803119115

Electronic and Magnetic Structure of Matter

Manuel Valvidares, Head of the Electronic and Magnetic Structure of Matter section (Experiments Division).

This section within the Experiments division includes the soft X-ray beamlines BOREAS, CIRCE and MISTRAL magnetism activities, as well as the Materials Science Laboratory. In the future, the LOREA beamline, currently under construction, will also be incorporated.

From the operational point of view, in 2018 both CIRCE and BOREAS beamlines received a large number of proposals of both national and EU/international origin resulting in considerable oversubscription (slightly over 2), in spite of enabling as much as 27 and 34 user experiments, respectively, in many cases involving complex in-situ sample preparation and UHV environment. For this reason, these beamlines delivered as much as 424 and 408 8-hour user shifts respectively, approaching maximum capacity. The productivity of the beamlines maintained a healthy increase in 2018 with respect to previous records, achieving CIRCE and BOREAS beamlines a high performance with 18 and 16 peer-reviewed publications, and more importantly, an exceptionally high average impact factor with 40% and 60% of publications with an impact factor > 7 , respectively. This performance evidences the high quality of the science performed by beamline user groups and cutting-edge capabilities offered by the beamlines of the section.

Remarkable novel capabilities were implemented at the beamlines enabling advanced experiments (performed this year and with results in 2018 and 2019, see highlights). Among the most remarkable ones is the development of gating capabilities and its use on Surface Acoustic Wave experiments driving ultra-fast magneto-elastic magnetic properties at the CIRCE-PEEM instrument or equally relevant developments at BOREAS soft X-ray scattering endstation, extending the available techniques with Fourier transform holography and coherent diffraction imaging approaches combined with low temperatures and high-applied magnetic fields.

Other relevant activities include the close scientific collaboration and PhDs co-directed by the ALBA scientific staff together with groups like the Institute of Physical Chemistry Rocasolano (IQFR-CSIC) working on in-situ growth and characterization of highly perfect magnetic oxides, the the Institute of Chemical Technology (ITQ-CSIC) doing in-operando catalysis investigations at CIRCE-NAPP or IMDEA Nanociencia investigating novel hybrid graphene/ferromagnetic structures. Besides, an international collaboration with MPI-Dresden allowed us to have a postdoc visitor at BOREAS-XMCD for researching on heavy correlated materials. Finally, during 2018, the section also received interns from the Institute of Physics of the Czech Academy of Sciences and IMDEA Nanociencia.

Insulator metal transition at the nanoscale

An international team of researchers was able to probe the insulator-conductor phase transition of materials at the nanoscale resolution.

Vanadium Dioxide (VO_2) is one type of material that can lead to a new generation of electronic devices. It can switch from an insulating to a metallic phase just above room temperature, a feature exploited already for sensors. However, the reason why the properties of this material change so dramatically has been a matter of scientific debate for over 50 years.

One of the challenges in understanding why and how this switch occurs is due to a process called phase separation. In VO_2 , insulating and metallic regions of the material can be coexisting at the same time during the transition. This separation occurs on the nanoscale and it is thus challenging to observe.

X-rays are a key tool for understanding the properties of materials. In this study, published in *Nano Letters*, a team of researchers from Institute of Photonic Sciences (ICFO) and ALBA in Barcelona, the Technische Universität and Max-Born Institute in Berlin, and Vanderbilt University in Tennessee, has been able to probe the phase transitions that occur in thin films of VO_2 using resonant soft X-ray holography. This technique, based on the interference of the beam transmitted through the sample and a reference aperture, enables imaging the electronic and structural changes in this material with an unprecedented resolution at the nanoscale without the need of a lens. By looking at the

material with 50 nm resolution, the scientists were able to observe that defects in the material played an important role in initiating the phase transition from the insulator to the metal. However, more importantly, the authors also observed a third intermediate state formed during the phase transformation. Whilst some regions transformed directly from the insulating to metallic phase, others transformed into a second different insulating state before becoming metallic at higher temperatures with the exact pathway taken depending on the defects present in the material. The coexistence of three phases has radically changed the views of previous studies that assumed the presence of only two states during the transition. Even more, the study presents new ways in which the transition could be controlled.

In addition to the results obtained on the phase transition in VO_2 , the work also highlights the possibilities that X-ray holography can bring for studying materials on the nanoscale. The technique is a unique method to image real-time nanoscale dynamics and is now being used to study the properties of other intriguing materials such as high temperature superconductors. Such a technique is becoming a relevant cutting edge approach implemented at a few synchrotrons in the world, and these results demonstrate that it is available at the multipurpose resonant scattering endstation, MaReS, of BOREAS beamline in ALBA.

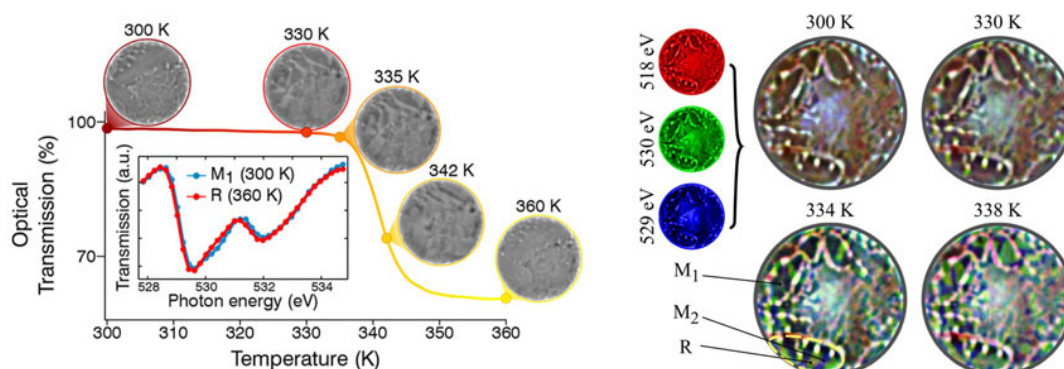

Figure 2: (left) Phase transition from insulator to metallic phase in VO_2 as a function of the temperature, with contrast exploiting linear x-ray dichroism; (right) reconstructed holograms at the vanadium and oxygen edges (518, 529, and 530.5 eV) used to encode the intensities of the three color channels of an RGB (red, green, blue) image. At 330 K, an increase in intensity of the green channel, which probes the metallic rutile phase (R) through the d_{II} state, is observed in small regions. As the sample is heated further, it becomes increasingly clear that the blue channel, which probes an intermediate insulating M_2 phase, also changes but in different regions. At 334 K, three distinct regions can be observed corresponding to the insulating monoclinic M_1 , M_2 , and metallic R phases. As the temperature increases, the R phase dominates. The circular field of view is $2 \mu\text{m}$ in diameter. (taken from Vidas et al, *Nanoletters*, 2018).

REFERENCE:

Imaging Nanometer Phase Coexistence at Defects During the Insulator–Metal Phase Transformation in VO_2 Thin Films by Resonant Soft X-ray Holography *Nanoletters* (2018) DOI: 10.1021/acs.nanolett.8b00458
Article done in collaboration with ICFO

Chemistry and Materials Science

François Fauth, Head of the Chemistry and Materials Science Section (Experiments Division).
Carlos Escudero, Beamline Scientist at CIRCE-NAPP (Experiments Division).

The Chemistry and Materials Science section encompasses the hard X-ray beamlines BL04-MSPD and BL22-CLAESS, dedicated to Powder Diffraction and Absorption Spectroscopy, respectively, and the soft X-ray CIRCE beamline (NAPP endstation), dedicated to near ambient pressure photoemission. It also includes the Chemistry and High Pressure laboratories.

From an operational point of view, BL04-MSPD, BL22-CLAESS and BL24-CIRCE-NAPP distributed the maximum possible beam time to academic users with 55, 37 and 20 accepted experiments, respectively. The reduced accepted experiments rate for BL22-CLAESS allowed us to commission important capabilities at the CLEAR spectrometer bringing to the beamline program an important emission effort. On BL04-MSPD, the high pressure powder diffraction techniques represented ~30% of academic beam time (17 experiments). As a significant experimental improvement we were able to integrate and commission a high pressure liquid helium cryostat providing low temperature capabilities. As is well established for several years, in-situ powder diffraction experiments on Operando batteries, with 13 experiments, is the most widely used technique/scientific field on the Powder Diffraction station.

The high oversubscription on BL22-CLAESS unfortunately led to decline scientifically sound proposals. Fifteen experiments were devoted to operando catalysis. As they required gas flow, they were demanding in terms of safety. BL22-CLAESS staff were heavily involved in performing safely these experiments. Other experiments are scattered in various scientific fields: energy related materials, strongly correlated electron systems and environmental science.

On BL24-CIRCE-NAPP the oversubscription ratio was close to 3.5, which highlights the high demand to access synchrotron NAPP-XPS systems around the

world. Most of the experiments of official users were devoted to heterogeneous catalysis but there were experiments related to other scientific topics such as batteries, catalytic nanomotors or oxide-based nano-electronic devices.

In terms of personnel, the section welcomed for the first time two PhD students, Marie-Skłodowska-Curie Early-Stage Researchers, within the framework of the DOCTORAL training program in Functional Advanced Material (DOC-FAM). This program was awarded to the Spanish National Research Council (CSIC) in the H2020-MSCA-COFUND-2016 Call and will clearly contribute to boost in-house and collaborative research and educational activities at ALBA. One student will develop her work at BL04-MSPD on energy related material oriented project, co-supervised by the beamline manager and a scientist from the ICMAB. The second student focuses on environmental science, being co-supervised by the beamline manager and UAB researchers. The BL22-CLAESS team incorporated a new external scientific visitor. On BL04-MSPD, new member whose project is oriented towards developing Pair Distribution Function type data collection and analysis replaced the former post-doc.

On BL24-CIRCE-NAPP, in addition to the two PhD students co-supervised by beamline staff, the Instituto de Tecnología Química and Universitat Politècnica de Catalunya, a new post-doctoral funded by the Argentinian Administration joined the beamline staff in October. His main project was devoted to studying atomic quantum clusters, a collaboration project involving the NAPP staff and the University of Santiago in Galicia which started three years ago.

At the chemistry laboratory, the Argon filled glove box in particular has been widely used by ALBA staff and academic users of all beamlines for sample preparation. The high pressure laboratory is essentially used by BL04-MSPD staff and users.

In search of more efficient catalysts for CO₂ reduction

A research group from Germany demonstrated the size-dependence effect of nanoparticles in catalysts during carbon dioxide electroreduction.

Converting carbon dioxide (CO₂) to produce new sources of chemicals and fuels is a promising strategy against climate change. Nevertheless, there is still a need to develop efficient and cost-effective catalysts suitable for large-scale industrial applications.

Catalysts are substances that increase the rate of a chemical reaction. However, it has been probed that the properties of the nanoparticles (NPs) used in catalysts (their size, shape or chemical state, the support material, etc.) can influence the catalytic reaction.

Scientists from the Ruhr-University Bochum and the Fritz-Haber-Institute of the Max-Planck Society have analysed how the size of zinc (Zn) nanoparticles (NPs) affects the activity and selectivity of CO₂ reduction.

They synthesized size-controlled Zn NPs, whose morphology was investigated via atomic force microscopy, with sizes ranging from 1.7 to 6.8 nanometers.

X-ray absorption experiments were carried out at the CLAESS beamline of the ALBA Synchrotron for gaining a deeper insight into the structure and chemical state of Zn NPs during CO₂ reduction under *operando* conditions. A home-made electrochemical cell was used.

Scientists found that there was a clear correlation between the coordination number of surface atoms and the catalytic performance. That means that the smaller the size of the Zn NPs, the bigger the catalytic activity. NPs ranging from 3 to 5 nm showed high activity and selectivity for CO production, while those above 5 nm presented bulk-like catalytic properties. NPs below 3 nm exhibited an increase in hydrogen production. The presence of residual cationic Zn species was also revealed and they might play a role in the selectivity trends obtained.

These results pave the way for designing new nano-catalysts for CO₂ reduction with the best possible efficiency.

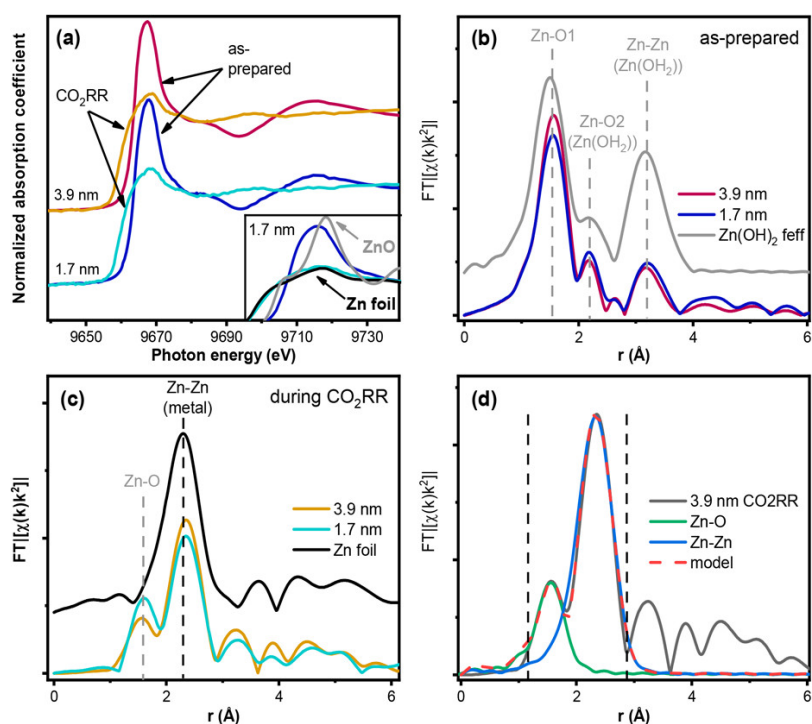

Figure 3: (a) Zn K-edge XANES data from 1.7 and 3.9 nm Zn NPs acquired in air and under *operando* CO₂RR conditions at -1.1 V vs RHE in 0.1 M KHCO₃. The inset shows the white line region of the 1.7 nm NPs together with bulk Zn and ZnO references. (b and c) Fourier-transformed k^2 -weighted EXAFS spectra of the same samples. Bulk Zn and an orthorhombic Zn(OH)₂ spectra modeled by FEFF are plotted as reference.⁽³⁰⁾ (d) 1st shell analysis of the EXAFS spectrum of 3.9 nm NPs during CO₂RR. Dashed vertical lines show the limits of the fit (taken from Sang et al, JACS, 2018).

REFERENCE:

Operando evolution of the Structure and Oxidation State of Size-Controlled Zn Nanoparticles during CO₂ Electroreduction *Journal of the American Chemical Society* (2018) DOI: 10.1021/jacs.8b05258

SUMMARY OF SELECTED HIGHLIGHTS

LIFE SCIENCES AND SOFT CONDENSED MATTER



"Synchrotron-based μ FTIR study on the effect of Alzheimer's A β amorphous and fibrillar aggregates on PC12 cells". DOI: 10.1021/acs.analchem.7b04818

BL01-MIRAS

DECIPHERING ALZHEIMER'S MECHANISMS

Alzheimer's affects more than 30 million people worldwide and still now there is no effective treatment to cure or prevent it. Researchers from the ALBA Synchrotron and the Universitat Autònoma de Barcelona (UAB) used synchrotron light to analyse the toxicity of different Alzheimer's aggregates, their location and their effect in cultivated neuronal cells.

BL13-XALOC

HOW LEGIONELLA MANIPULATES THE HOST CELL

Scientists from CIC bioGUNE, in collaboration with other groups from the National Institutes of Health in the United States, solved the structure of RavN, a protein that *Legionella pneumophila* uses for stealing functions and resources of the host cell. They were able to prove how Legionella uses molecular mimicry to exploit ubiquitination, a process that modifies proteins containing ubiquitin for their participation in different cellular processes.



"RavN is a member of a previously unrecognized group of Legionella pneumophila E3 ubiquitin ligases". DOI: 10.1371/journal.ppat.1006897

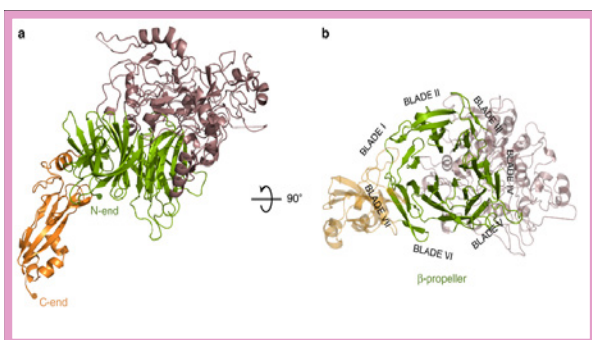

"Mycoplasma genitalium adhesion P110 binds sialic-acid human receptors". DOI: 10.1038 / s41467-018-06963-i

BL13-XALOC

HELPING FIGHT GENITOURINARY DISEASES

Mycoplasma genitalium is a sexually transmitted bacterium responsible for several genitourinary disorders. The structure of the protein involved in the pathogen's adhesion process was resolved by a group of scientists from the Molecular Biology Institute of Barcelona (IBMB-CSIC) and the Institute of Biotechnology and Biomedicine (IBB-UAB). These results open the door to defining new therapeutic strategies to fight this pathogen which is becoming increasingly resistant to antibiotics.

BL01-MIRAS

HOW SUN RADIATION DAMAGES SKIN AND HAIR

Researchers from the Institute of Advanced Chemistry of Catalonia (IQAC-CSIC) investigated damage on skin and hair caused by ultraviolet sunlight. They could observe the changes occurring at the molecular level with high resolution and accurate detail, not only at the surface but also in the inner layers of skin and hair. The samples had been previously treated with resveratrol, a well-known antioxidant, to evaluate how effective is to develop new and better photoprotective treatments based on this component.



CHEMISTRY AND MATERIALS SCIENCE

BL24-CIRCE NAPP

UNRAVELLING THE WATER CONDENSATION ON PHOTOACTIVE NANOTUBES

Researchers from the Materials Science Institute of Seville (CSIC) and the ALBA Synchrotron characterized the water condensation mechanisms on titanium dioxide photoactive nanotubes' surfaces after ultraviolet irradiation. Thanks to this method, the material-water interaction can be controlled, changing its properties and enabling to convert the nanotubes in either hydrophilic or hydrophobic surfaces depending on the objective. This specific feature is of great interest to architecture and transport, in order to develop antifogging or antifreezing surfaces.



"In Situ Determination of the Water Condensation Mechanisms on Superhydrophobic and Superhydrophilic Titanium Dioxide Nanotubes". DOI: 10.1021/acs.langmuir.7b00156



"Multiscale understanding of tricalcium silicate hydration reactions". DOI: 10.1038/s41598-018-26943-y

BL04-MSPD

THE SCIENTIFIC ENDEAVOURS OF CEMENT HYDRATION

The hydration of alite, the main component of ubiquitous Portland cement, was studied by an international team of researchers. Using a multi-technique approach including synchrotron Pair Distribution Function analysis, they were able to quantitatively monitor the alite hydration process. The results showed that calcium-silicate-hydrates gel is composed of defective clinotobermorite nanoparticles within a monolayer calcium hydroxide soup.

BL24-CIRCE NAPP

NEW INSIGHTS ABOUT COBALT CATALYSTS FOR HYDROGEN PRODUCTION

Cobalt-based catalysts are a promising alternative for hydrogen production, which could be used in vehicles or industrial applications in the future. Researchers from ALBA, Universitat Politècnica de Catalunya (UPC) and Universidad Nacional de San Martín (UNSAM) studied the chemical state of cobalt in three different cobalt-based catalysts during the ethanol steam reforming (ESR) reaction, a safe and controlled process for generating hydrogen on board that can however result in the deactivation of the catalyst by carbon deposition.



"Unraveling the Chemical State of Cobalt in Co-Based Catalysts during Ethanol Steam Reforming: an in Situ Study by Near Ambient Pressure XPS and XANES". DOI: 10.1021/acscatal.8b02666

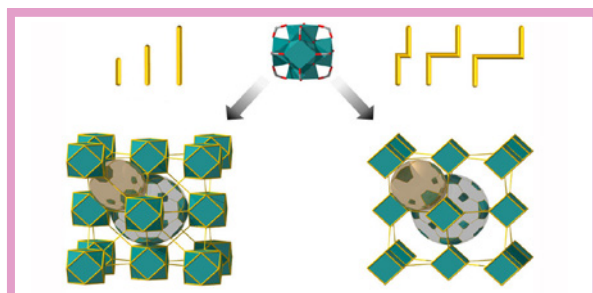

"Zigzag Ligands for Transversal Design in Reticular Chemistry: Unveiling New Structural Opportunities for Metal-Organic Frameworks". DOI: 10.1021/jacs.8b07050

BL13-XALOC

USING ZIGZAG LIGANDS TO CREATE METAL ORGANIC FRAMEWORKS (MOFs)

MOFs are a revolutionary class of materials constructed from metal ions/clusters and organic ligands that link together via self-assembly. Researchers from the Catalan Institute of Nanoscience and Nanotechnology (ICN2) used synchrotron light to report the first-ever article about zigzag linkers for transversal design in reticular chemistry.

BL04-MSPD

A CLOSER LOOK AT ZINC BEHAVIOUR UNDER EXTREME CONDITIONS

Researchers from the University of Valencia explored the phase diagram of zinc under high pressure and high temperature conditions, finding evidence of a change in its structural behaviour at 10 GPa. This experiment helps to understand the processes and phenomena occurring in the inner core of the Earth but also to define new industrial uses for this material that is already being applied in sectors such as construction, ship-building or automobile.

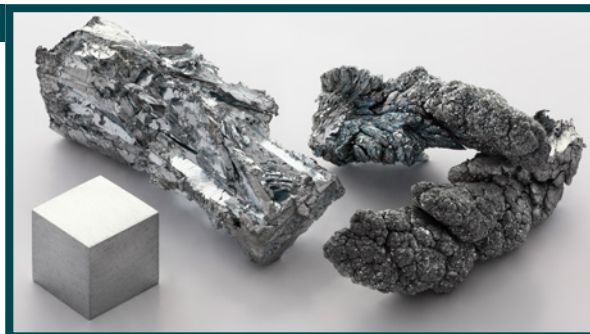

"High-pressure/high-temperature phase diagram of zinc". DOI: 10.1088/1361-648X/aacac0



"Structural effects of microalgae additives on the starch gelatinization process". DOI: 10.1016/j.foodhyd.2017.10.002

BL11-NCD-SWEET

DEVELOPING BIOPOLYMERS BASED ON ALGAE FOR THE FOOD INDUSTRY

A research group from the Institute of Agrochemistry and Food Technology (IATA-CSIC) has used scattering techniques at ALBA to develop new packaging systems made of biopolymers, an environmentally friendly solution for the food industry. They analysed how adding different microalgae species can modify the properties of starch-based biopolymers, finding that Spirulina microalgae is a promising alternative for replacing part of the corn starch matrix of biopolymers, as it improves the oxygen and water vapour barrier properties, thus maintaining food in better conditions.

ELECTRONIC AND MAGNETIC STRUCTURE OF MATTER

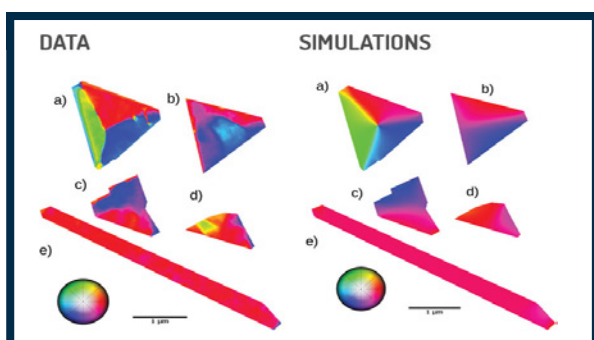

"Geometrically defined spin structures in ultrathin Fe₃O₄ with bulk like magnetic properties". DOI: 10.1039 / c7nr07143d

BL24-CIRCE PEEM

RESEARCHERS OBTAINED NANOMETRIC MAGNETITE WITH FULL PROPERTIES

Magnetite is a candidate material for various applications in spintronics, meaning that can be employed in devices where the spin of the electron is used to store or manipulate information. However, when reducing materials at the nanoscale, they typically lose some of their properties. Researchers from the Instituto de Física Química "Rocasolano" and ALBA determined the magnetic domains and Curie's temperature proving that, with suitable growth, magnetite could be used to create nanostructured magnetic elements without losing its properties.

DISENTANGLING THE ORIGIN OF MAGNETIC PROXIMITY EFFECTS IN Pt/CoFe₂O₄

Researchers from the Institute of Materials Sciences of Barcelona (ICMAB-CSIC) and ALBA analysed the microscopic origin of the so-called “magnetic proximity effect” occurring at the interface between a magnetic material (CoFe₂O₄) and a nonmagnetic metal (Pt), which may induce a magnetic moment in the latter. The results are relevant for understanding spin currents generated in metallic layers having a large spin orbit coupling.

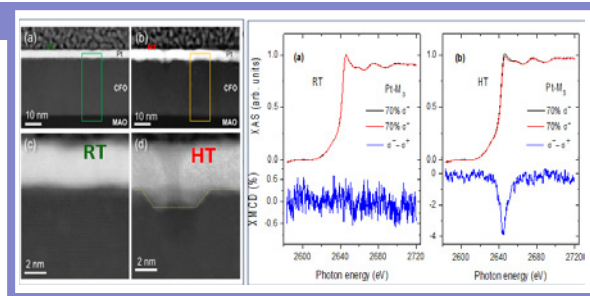

“Magnetoresistance in Hybrid Pt/CoFe₂O₄ Bilayers Controlled by Competing Spin Accumulation and Interfacial Chemical Reconstruction”. DOI: 10.1021/acsami.8b00384

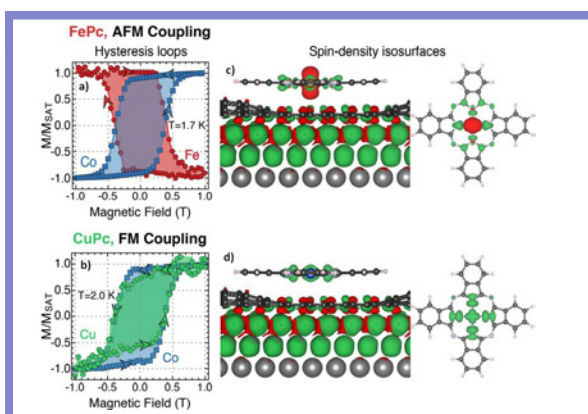

“Ferromagnetic and Antiferromagnetic Coupling of Spin Molecular Interfaces with High Thermal Stability”. DOI: 10.1021/acs.nanolett.7b04836

FERROMAGNETIC AND ANTIFERROMAGNETIC COUPLING OF SPIN MOLECULAR INTERFACES WITH HIGH THERMAL STABILITY

A group of researchers from the Università La Sapienza, Centro S3 of Modena and ALBA demonstrated that magnetic coupling of metal-organic molecules to a magnetic substrate mediated by a graphene layer can be tuned in strength and direction by choosing the symmetry of the molecular orbitals that is largely preserved thanks to the graphene layer. This can open the route to engineering highly spin-polarized, nanoscale current sources.

MAGNETIZATION RATCHET IN CYLINDRICAL NANOWIRES

A team of researchers from the Materials Science Institute of Madrid (CSIC), the University of Barcelona and the ALBA Synchrotron reported on magnetization ratchet effect observed for the first time in cylindrical magnetic nanowires (magnetic cylinders with diameters of 120nm and lengths of over 20μm). These nanowires are considered as building blocks for future 3D (vertical) electronic and information storage devices as well as for applications in biological sensing and medicine.

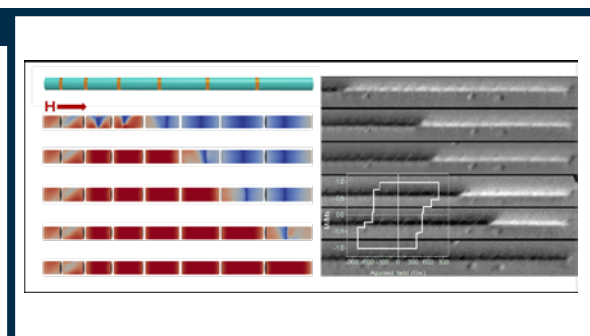

“Magnetization Ratchet in Cylindrical Nanowires”. DOI: 10.1021/acs.nano.8b02153

INDUSTRY

Marta Ávila, Alejandro Sánchez, Núria Valls
ALBA Industrial Liaison Office

One of the main goals of ALBA is to build bridges with the private sector, offering state-of-the-art synchrotron techniques and developments to improve their innovation and competitiveness.

Synchrotron techniques for industry and CALIPSOplus

During 2018, most of the beamlines were having industrial projects, mainly coming from the nanotechnology and pharmaceutical sectors, but also from cosmetics, catalysis, energy or chemistry. In total, **25 different companies** were doing measurements at ALBA **and the portfolio of customers increased with 11 new companies**. Interestingly, 9 of these companies are Spanish, which recognizes and supports the Spanish innovation and research system. Additionally, it is also very important for ALBA to be recognized by companies around the world. In that sense, one new company from US and one from France were accessing ALBA facility. ALBA has signed long-term contracts with some of these companies not only for providing punctual beamtime access but for long-term services and investment in new beamlines.

The launch of **TamaTA** (a work package of the European project CALIPSOplus) has been instrumental in developing the innovation capability of ALBA. **It is led by ALBA and ESRF with 10 different light sources participating. Its goal is to lower the access barriers between companies and light sources**, facilitating SMEs access to these type of infrastructures. A single entry point has been created, with a very simple form, where companies can submit their proposal and receive the help of the industrial liaison offices of the different partners (<https://www.wayforlight.eu/en/industries/>). During 2018, **17 companies have submitted proposals, 16 of them have been granted and 4 of them requesting access to ALBA** (Figure 4). It has been shown to be a very useful tool for companies that are not aware of the possibilities of synchrotrons. One of these success stories is presented in the next page. Additionally, a noteworthy result of TamaTA is that different light sources cooperated to provide a joint service to a particular SME (shared proposals).

In the technology development and technology transfer field, more patents have been filed in 2018 thanks to the ALBA scientists and engineers. It is worth to mention that the industrial PhD student supported by a company and a Catalan grant successfully defended his thesis. The technology development findings were very useful for both, the company and ALBA.

Industrial outreach activities

The ALBA industrial liaison office promotes and enhances the awareness of synchrotron techniques among the industrial community. One of the main activities is organizing industrial workshops addressed to specific industrial sectors. During 2018, two different industrial workshops were held at the ALBA Synchrotron premises.

The first one, on April 17, focused on **advanced materials research for automotive applications**. This workshop was organized in collaboration with the clusters secpho, CIAC and ClusterMAV. During the one-day workshop, nearly 70 attendees had the opportunity to learn about the applications of synchrotron light to the automotive sector and they could gain knowledge on new features and trends of advanced materials used in the automotive sector.

The second industrial workshop, held on June 1, was addressed to companies from the **metallurgy and surface sectors** and it was organized in collaboration with the metallurgical industrial associations FEM, CENTREM, UEM and ALIAS. Different presentations by scientists of ALBA and the experimental hall and beamlines visit provided an overview of the application of ALBA techniques for the



Scientific presentation during the metallurgy and surface industrial workshop.

characterization of the oxidation of alloys, surface corrosion processes, porosity and microstructure in alloys and stir welds or the effects of thermal treatments on metals. More

than 50 attendees came to ALBA and, according to them, **the workshop was very interesting and look forward to benefiting from ALBA techniques.**

INDUSTRIAL USAGE / YEAR

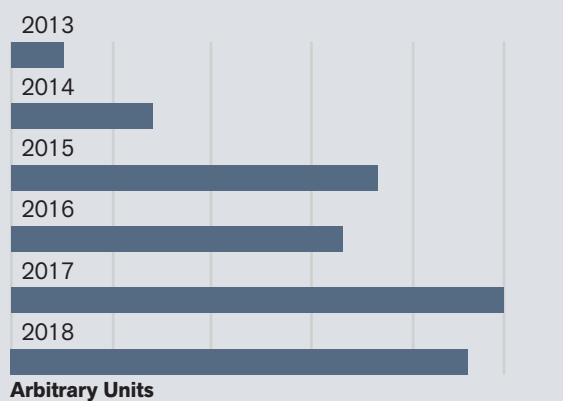

Figure 4: Evolution of industrial beamtime per year in arbitrary units

TAMATA- CALIPSOplus NUMBER OF PROPOSALS OF SMEs / LIGHT SOURCE

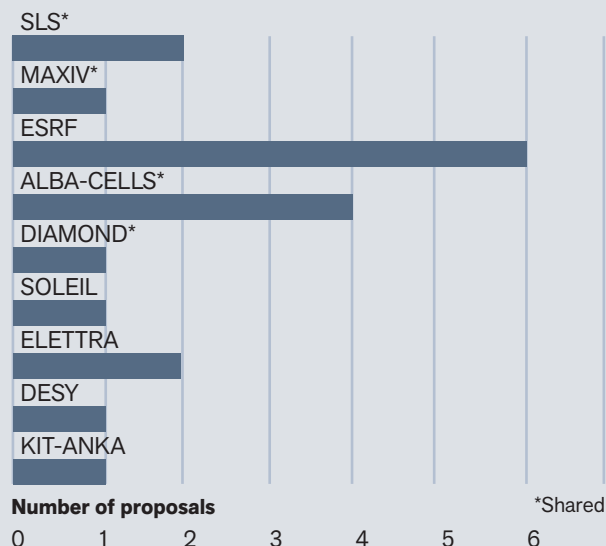
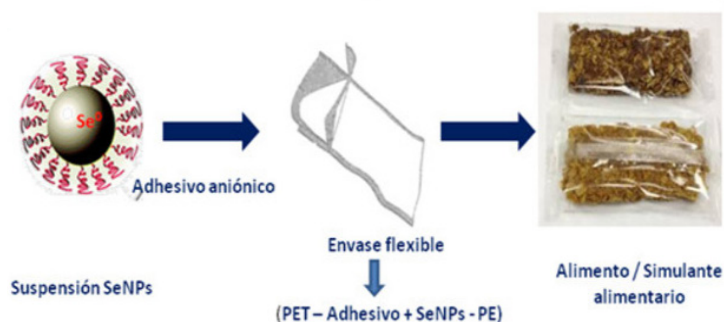

Figure 5: Number of proposals per light source submitted through the single portal of TamaTA during 2018



Synchrotron light for improving industrial food packaging

The SAMTACK company has used ALBA's techniques to analyse nanoparticles contained in a new food packaging system that will prevent food oxidation and extend its lifetime.

We all expect to purchase high quality and fresh food that, even if it has been kept for some days in the supermarket shelf, keeps its optimum safety, quality and flavor. Different ambient conditions can modify food quality: moisture can affect the crispness of the product, oxygen can oxidize food with large fat components (e.g. potato chips) and modify its taste, while light can degrade vitamins from milk or even remove the aromatic and volatile components from ground coffee and cause off-taste. Hence, different barriers are required to protect food from moisture, oxygen or light. Packaging acts as a barrier and extends the product's shelf life while contributing to diminish the amount of food that is thrown away and to avoid overproduction of food.

Free radicals are formed spontaneously from oxygen, moisture and UV radiation and initiate oxidation reactions very quickly. As free radicals are very small, they are capable of going through the plastic layers. Samtack is a company founded in 1988 and based in Esparreguera (Barcelona) that manufactures glues and adhesives specialized in the sector of graphic arts and packaging. In collaboration with the University of Zaragoza and the Complutense University of Madrid, **Samtack has developed a new flexible multilayer system that enlarges food shelf life.**

This new multilayer system contains **Selenium nanoparticles** in one of its layers. These Selenium nanoparticles are capable of **absorbing free radicals**, inhibiting the possible oxidation of food and therefore maintaining its properties longer. However, not all Selenium oxidation states are equally capable of absorbing free radicals: while Selenium nanoparticles in their elemental state (Se0) have a high capacity, other oxidation states (SeIV or SeVI) are not so effective.

The synchrotron technique X-ray Absorption Spectroscopy (XAS), available at ALBA Synchrotron, allows **distinguishing the different oxidation states of most of the chemical elements**, Selenium amongst them, and can as well determine their chemical composition directly on the sample, with minimum sample preparation. Different laminates containing Selenium nanoparticles fabricated as Se(0) were examined using the XAS technique at ALBA. The results showed that in some sample preparations, Selenium was moderately oxidized to oxidation state Se(IV). This provided Samtack with **very valuable information to improve the synthesis of this new flexible multilayer system.**

These measurements were the **first experiments performed at ALBA taking advantage of TamaTA funding**, a work package from the European project CALIPSOplus described previously.

ACCELERATORS

Francis Pérez, Head of the Accelerators Division

The year 2018 has been a busy year, as always, for the Accelerator's team, with satisfying successful projects and the usual activities for maintaining, operating and improving the complex of the three ALBA accelerators: the Linac, the Booster and the Storage Ring.

The main difficulty has been the impossibility to operate reliably at 200mA during users' operation. The reason has been the unexpected beam induced **overheating of the Superconducting Wiggler (SCW)** of the MSPD beamline, resulting in several magnet quenches and some beam losses. We have chosen to prioritise facility reliability, maintaining the operation current at 150 mA until the problem could be fixed, which was programmed for January 2019.

On the other hand, several projects have been concluded successfully along the year. One was the upgrade of the **radiofrequency power system of the Booster cavity**, replacing the original tube based system with a new solid state power amplifier (SSPA). During August, the old system was completely dismantled and the new one installed and tested, the works were performed flawless and the new system was ready to operate in time for the September re-start. A nice time-lapse can be seen at <https://www.cells.es/en/media/news/spanish-technology-for-alba-booster-rf-amplifier>.

Another development which we are proud of is the implementation of a new method to measure the relative position of the electron beam with respect to the magnetic center of the quadrupole magnets, this is important in order to ensure the proper performance of the Storage Ring. The new method, called **Fast Beam Based Alignment (FBBA)**, allowed to reduce the measuring time from 5 hours to just 10 min. Results have been published at <https://doi.org/10.18429/JACoW-IPAC2018-TUPML078>.

In terms of the contribution of the accelerators team to the new beamlines projects, three contracts have been timely signed for the purchasing of the in **vacuum undulator for the XAIRA** beamline, and the **front-ends for the NOTOS and XAIRA** ones.

In addition, we have been actively involved in several **international collaborations** in accelerator's R&D. In the



Old tube based Booster RF power system (top), and the new SSPA one (bottom).

following page, details of the collaboration with the CERN CLIC project are given. But we are also involved in several H2020 projects, including the EuroCirCol collaboration for the design of the future circular collider FCC, the Compact Light Source XLS collaboration; and the ARIES one, for new accelerator technologies development.

Other **lab-to-lab collaborations** include the development of a software tool for the characterization of the Beam Position Monitors (BPMs) for the EBS project at ESRF; and the delivery of the digital Low Level RF (LLRF) system for the Brazilian project SIRIUS.

Finally, we have organized several **workshops and meetings**: a *Workshop on Emittance Measurements for Light Sources and FELs* (<https://indico.cells.es/event/128/>), a *Workshop on Next Generation Beam Position Acquisition and Feedback Systems* (<https://indico.cern.ch/event/743699/>); and the *First XLS – Compact Light Annual Meeting* (<https://indico.cells.es/event/177/>).



Inductive adders installed next to the stripline in the ALBA Storage Ring tunnel.

Testing CLIC pulse modulators at ALBA

Montse Pont, Head of Operations of ALBA Accelerators

CLIC stands for Compact Linear Collider, and together with the Future Circular Collider is one of the two approaches that CERN is studying as the post-HL-LHC accelerator. CLIC would be a TeV high-luminosity electron-positron linear collider, providing precision measurements of the Higgs boson, as well as a powerful tool to search for new physics processes.

CLIC is an **international collaboration** of more than 70 institutes in more than 30 countries, in which **ALBA has been active since 2015**. The culmination of the ALBA participation has been the installation and commissioning with beam at the ALBA Storage Ring of a **stripline kicker powered with pulse modulators** designed and built at CERN.

To achieve high luminosity at the interaction point of the collider, it is essential that the colliding beams have **very low transverse emittance**. This is ensured by the damping rings (DR in the diagram to the right). The stripline kickers which are electromagnetic deflecting structures to extract the beams from the damping rings must provide **extremely stable field pulses to keep this low emittance**. Each DR extraction kicker system consists of a set of two striplines and two pulse modulators. Specifications for this system require that the modulator produce pulses 900ns long, $\pm 12.5\text{ kV}$ of amplitude, with ripple and droop below $\pm 2.5\text{ V}$. Inductive adder topology has been chosen for the pulse modulators.

One extraction kicker with two inductive adders has been designed and built at CERN and installed and tested with beam at ALBA.

After conditioning in the laboratory, **measurements have been carried out with a single bunch beam** of $\sim 3\text{ mA}$. The beam was kicked vertically at 3Hz with a pulse 160ns long. The timing of the kicker pulse was changed to scan the kick field uniformity in time. The kick amplitude was obtained from the amplitude of the betatron motion measured using 120 beam-position monitors (BPMs), over 400 turns. The

measurements shown were carried out at $\pm 5\text{ kV}$ stripline voltages. The raw pulse (red curve) was consistent with the simulations performed at CERN and the droop compensation correction was successfully tested (blue and green curves below indicate different levels of correction applied).

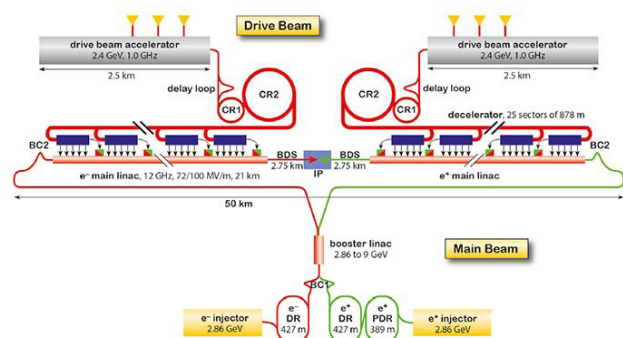

Figure 6: Schematic layout of the CLIC complex. Next to the injectors at the bottom of the picture are the two damping rings, one for electrons and one for positrons.

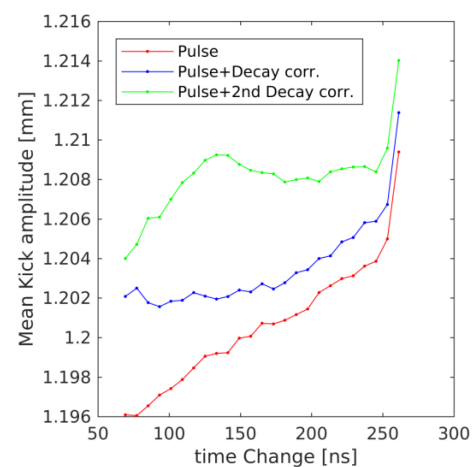

Figure 7: Three measured waveforms at $\pm 5\text{ kV}$ with different levels of droop correction applied.

REFERENCES:

- [1] Updated baseline for a staged Compact Linear Collider, CERN Yellow Report, 2018, doi:10.5170/CERN-2016-004
- [2] J.Holma et al, Proceedings of the IPAC Conference 2019, doi:10.18429/JACoW-IPAC2019-THPRB071

Joan Casas, Head of the Engineering Division

The Engineering Division comprises a team of 36 multi-disciplinary engineers and technicians who give support to the other divisions in ALBA, and maintain and upgrade the general infrastructures and services of the facility. It consists of two sections, the “**Infrastructures Section (IS)**”, and the “**Transversal Section (TS)**”. The first one is devoted to **civil engineering projects** (construction and technical services/ supplies like electric power, compressed air, technical gases, de-ionized water) and **maintenance of facilities and processes** (electrical and mechanical maintenance including HVAC, compressed air and dynamic UPS, among others). The second one provides **multi-disciplinary engineering services** to the beamlines and the accelerator, and support to the **operation on vacuum, cryogenics and logistics**. These engineers also support beamline operation with many projects for minor or medium upgrades. In new beamlines, they play a key role not only as developers of specific instrumentation, but also giving technical management support to scientists.

OPERATIONAL BEAMLINES IN GOOD SHAPE

During the year, several activities have been developed by members of both sections in order to keep a good performance of the operational beamlines. The MISTRAL beamline fully motorized the M1 mirror bender in order to allow more degrees of freedom for the alignment and focusing of the X-ray beam. The beam conditioning elements at the end-station of MSPD were also upgraded, as well as the temperature control at the optical hutch. A new beam stopper and a new support set-up for GIWAXS were developed for NCD-SWEET. At XALOC, a new Helium chamber was inserted between the sample (at the diffractometer) and the detector in order to operate at low photon energies. At CLAEISS, a new pin-hole and a new support for a SSD filter was developed, and the Dynaflo set-up was integrated. The control hutch of the beamline was enlarged and the gas systems was upgraded. At CIRCE, the design of a new manipulator (sample positioning with 6 degrees of freedom, high voltage and cryogenics) was finished and a new handle tooling for the manipulator of the NAPP was implemented for a better install and un-install operation. Finally, at BOREAS, engineering support was given to the acquisition of the radial distribution chamber and the sample transfer for the ALI system.

INTENSE ACTIVITY FOR THE NEW BEAMLINES

The three beamlines under construction required a lot of support from both sections. The Engineering team has thoroughly participated in the preparation of **calls for tenders** for different equipment and the design of the **radiological protection hutches**.

LOREA required support for the overall beamline design and construction. The storage ring bending magnet chamber with the associated absorbers, spares (straight section) and NEG chambers were reviewed by our vacuum engineers. The third compacted version of the Nanobender was finished (at design level), and the design of the second order corrector for the insertion device was also completed. During all the year, the design of the **monochromator** involved up to four engineers that obtained some first positive experimental results with a novel cooling system which excludes vacuum guards and allows faster thermalization when beam opening. The design of the installations for the technical supplies (compressed air, nitrogen and de-ionized water for cooling) was also done. At **XAIRA**, the selected insertion device required a new design of absorbers to match radiation acceptance. Some upgrades of the closed gap ID measurement test bench at the magnetics lab were also driven by XAIRA, due to the measurement of the in-vacuum undulator (new smaller rotating coils were developed). Engineers also gave support to the back-bone specifications, and they designed the up-stream and down-stream vacuum chambers for the integration of the straight section of the in-vacuum undulator. New absorbers to match the radiation acceptance window of the bending magnet of **NOTOS** were designed. The integration of elements coming from ESRF BM25 was also developed and support was given to the preparation of the call for tenders for the new monochromator.

Other activities are also worth pointing out. Medium size upgrades were carried out (new gases exhaust or design and contracting of a new storage area for Controls & Computing) and some significant maintenance tasks, over the standard preventive maintenance plan: new anti-vibration slabs were installed at pumps P07 (experimental hall) and P09 (booster) of the de-ionized water system, and the glass cover at the atrium was repaired.

The ALBA adaptive mirror bender

Carles Colldelram, Head of the Transversal Section (Engineering Division)
 Josep Nicolàs, Head of the Optics & Metrology Section (Experiments Division)

3rd generation of the ALBA bender, a completely new design which is much more compact, simplified and performant.

Every modern synchrotron light source is designed to obtain the smallest possible emittance (the product of horizontal size and divergence of the electron beam) in order to achieve photon source with the highest brilliance. That is, sources that provide simultaneously very high photon density and collimation, as this represents a fundamental limit for the actual photon flux that can be delivered to the samples, among other quality parameters.

However, a high brilliance photon source is of little use if the brilliance is degraded by the optical elements between the source and the samples under study. In other words, optical elements and optomechanical systems capable of preserving the brilliance along the beamline are required. For instance, often, mirror surface errors as small as a few nanometers are enough to spoil the spot size on the samples, the spectral resolution of a monochromator, or the homogeneity of the illumination in an imaging beamline.

Recently, significant advances have been made in X-ray optics technology, especially in mirror fabrication. Several manufacturers are able of producing mirrors with optical

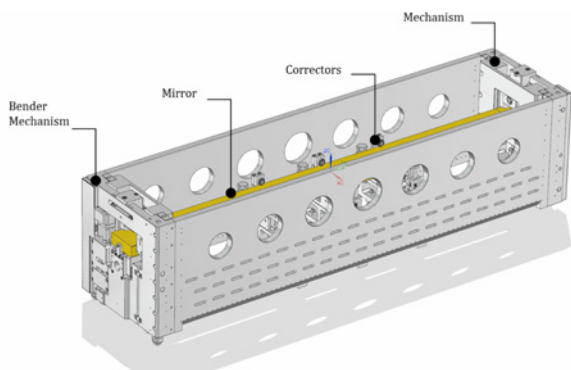

Figure 8: Design of the ALBA mirror bender, indicating the main mechanical parts.

surfaces polished to sub-nanometer quality. Such high quality mirrors require also high quality mechanics around them to preserve their surface figure. This needs mechanics much more demanding than those used in the past.

Following this idea, ALBA has developed its own mirror bender system. A mirror bender is a mechanical system that holds

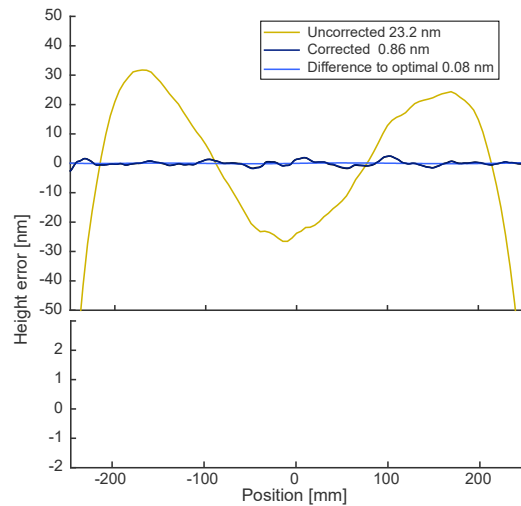

Figure 9: Residual height profile measured on a bent ellipse. The initial figure error of the mirror (23.2 nm rms) is corrected using four additional actuators, achieving a figure error of 0.86 nm rms. The difference between the obtained figure and the optimal figure achievable with correctors is 0.08 nm rms as shown in the lower part of the figure .

the mirror and that can introduce controlled torques at the extremities of the mirror substrate so that its surface, originally flat, is bent onto a focusing elliptical figure. The applied torques are normally motorized, what allows optimizing the focus distance of the mirror during operation. The ALBA mirror bender however, goes beyond just controlling the focus, and has been designed as true adaptive optics system.

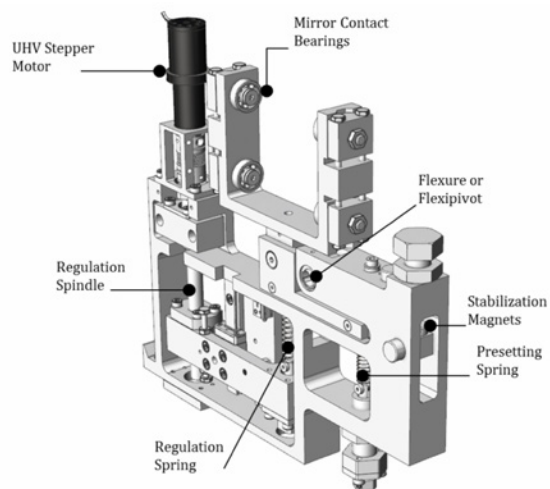
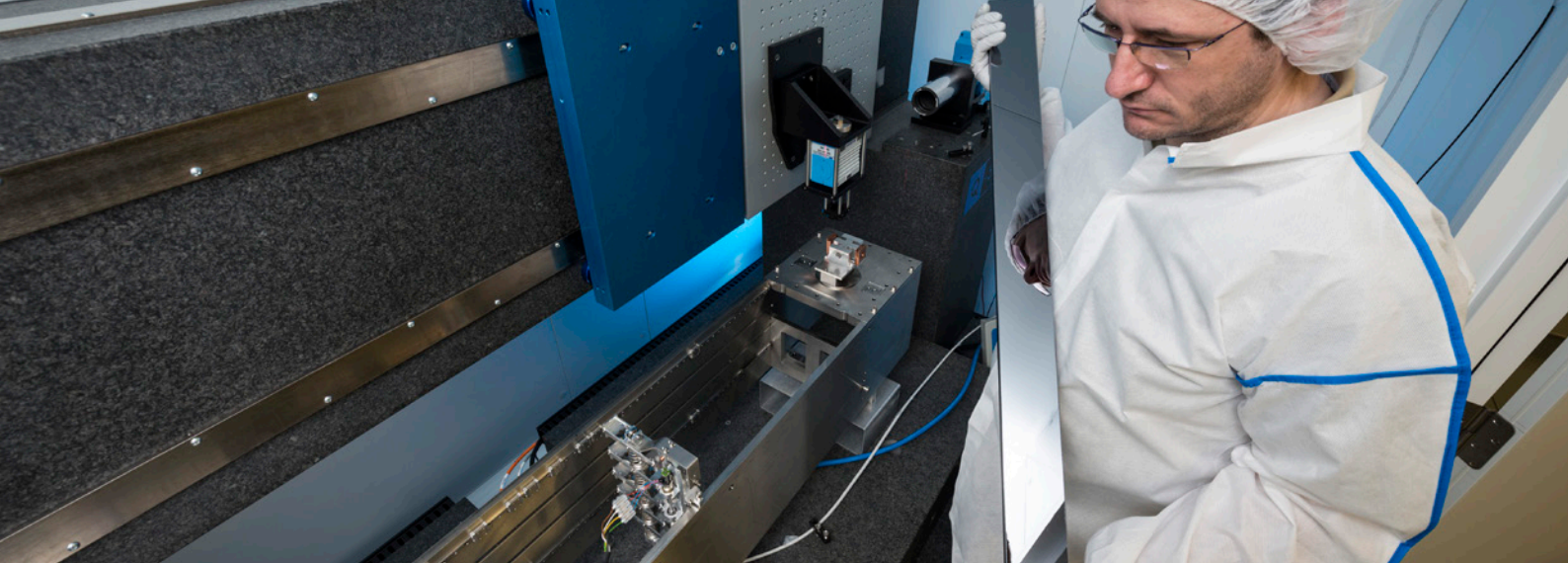

Figure 10: Design of the figure corrector, indicating the most relevant mechanical components.



Metrology test of the nanobender at the ALBA Optics and Metrology laboratory.

It includes a number of motorized actuators along the mirror, that provide a more flexible control of the optical surface, and with a resolution better than one nanometer.

In order to achieve the required control of the mirror surface, the ALBA mirror bender is designed to minimize parasitic deformations of the mirror figure. To this end, friction is systematically avoided, and all the parts in contact with the mirror are articulated in a way that cancels any force component other than normal to the mirror surface. Torsion and longitudinal stress are also controlled in this way. In addition, in order to control accurately the bending forces, the whole bending mechanism has been made robust and compact. It is entirely UHV compatible, and does not have any vacuum-to-air mechanical transmission, which is intrinsically unstable. The bending torque actually applied to the mirror is measured by means of load cells inserted in the force transmission chain, next to the mirror contact parts. They provide a reliable feedback of the actual figure of the mirror.

The design follows also practical considerations. The bender system is just 20 mm longer than the mirror itself, which is beneficial when one needs to minimize the distance between mirror and sample. The center of mass of the mechanics and the mirror surface are approximately centered in the volume delimited by the mechanics. This contributes for a better vibration stability of the system support, and allows keeping the volume of the containing vacuum vessels to a reasonable size.

The bender can also be equipped with adaptive optics actuators. Their number can be chosen, as well as their position along the mirror substrate depending on the specific purpose allowing to modify the figure of the mirror during beamline operation. For instance, it allows beam-shaping, or wavefront error compensation, which useful for when there is a changing thermal load on any optical element of the beamlines. The correctors also allow decreasing

the residual errors of the mirror surface to sub-nanometer scale, regardless of their causes, gravity, polishing defects or thermal deformations.

The actuators follow the same design principle as the rest of the system. They avoid friction as well as any other parasitic force. They are also driven by a fully UHV compatible mechanism that controls the force exerted by a couple of springs. For the standard configuration the actuator forces range from -20N to +20N with resolution better than 0.001 N, which is enough for sub-nanometer control of the mirror surface. The correctors include also a pair of magnets that can be adjusted to stabilize the force applied by the corrector.

A prototype shown in Fig. X has been built to check the actual performances of the bender including its actuators. Test in the Alba optics laboratory indicated that the bender can obtain elliptic surfaces with an error below 1 nm rms, departing from a flat mirror, with a surface error of 23 nm rms (see figure 4). The corrected figure was measured to be stable for more than three days. The bender was cycled through different bending configurations resulting in a repeatability of the mean curvature as good as $4 \cdot 10^{-6}$, equivalent to figure errors with respect to the target ellipse below 0.12 nm rms. The tests of the correctors indicated that the resolution of the forces applied to the mirror is 0.001 N and that they can preserve their stability below 0.01 N for the complete curvature range of the mirror. This level of resolution and stability ensures the stable control of the mirror surface at beamline operation.

These results meet and exceed all the performances expected for the system, and demonstrate that the Alba mirror bender is ready for the future beamlines of ALBA. The first five units are currently being produced and will be installed in the LOREA and XAIRA beamlines, which require beam dimensions at the sample position around one micron.

REFERENCES:

[presented at the SRI 2018] "Adaptive Optics Bender with Sub-Nanometer Correction and Stability" AIP Conference Proceedings 2054, 060013 (2019); doi: 10.1063/1.5084644

Design, production and testing of a novel glidcop crotch absorber for LOREA

Marcos Quispe, Engineer of the Transversal Section (Engineering Division)
Artur Gevorgyan, Engineer of the Transversal Section (Engineering Division)

A Novel Glidcop Crotch Absorber was designed to operate under the special conditions of the insertion device (ID) radiation source.

The undulator of the LOREA beamline will generate, in vertical polarization mode, a power load which exceeds the maximum acceptable of the standard ALBA front ends. Simulations show that due to their small acceptance, the temperature would raise up to 950 °C, well above the maximum tolerable limit. A new design has been carried out and implemented to face this difficulty.

For the novel crotch absorber, part of the ID radiation must be absorbed by its opening in order to protect the post dipole chamber from any collision. The new absorber geometry includes: modifications in the inclination of the surface where the ID radiation is deposited, an additional safe angle at the entrance of the opening, considerations to guarantee that all the ID radiation is always deposited below the cooling channels, definition of minimal thickness between the water cooling channels and the vacuum zone, considerations to avoid any possibility of corrosion in cooling holes induced by radiation, a slot at the end of the absorber to have all the BM radiation always below the position of the cooling channels, and criteria to avoid direct reflection of radiation from the absorber to the dipole chamber.

Iterative calculations were made for the design phase using the **simulation tools SynRad+ and ANSYS**. Later

on coupled simulations have been made in **Molflow+** to guarantee required vacuum levels and to evaluate expected gas load during the machine operation.

The company **CINEL** has manufactured the new absorber, based on the design proposed by the authors. The final product has been **tested in ALBA from the point of view of metrology, vacuum and cooling issues**.

For the vacuum test, prior to bake out, a visual inspection has been done to ensure that the sealing surfaces of the flange, brazing and welding joints are free of any defects, scratches, cracks and visible contaminations. The absorber was pumped down, leak and RGA tested. Regarding bake out conditions we found no leakage profile and no contaminations.

As for the alignment and dimensional testing we have verified distances, shape and geometrical tolerances. As regards cooling issues, the correlation has been checked between the flow rate and the pressure drop, and a maximum-pressure test has also been done.

For all tests the absorber meets the criteria defined in ALBA for the operation.

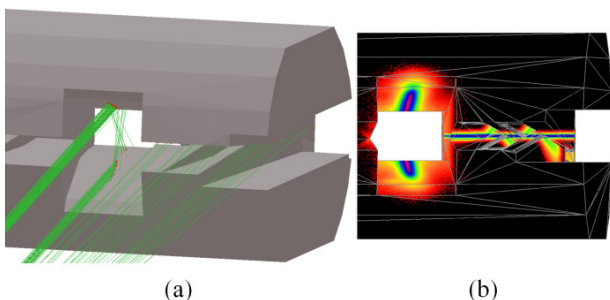

Fig 11: Absorber simulated by using SynRad+. (a) Details of the photon beam trajectory. (b) The footprint of the ID and BM radiation.

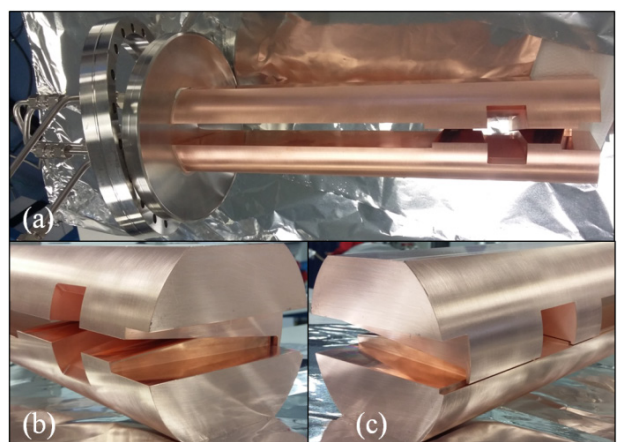

Fig 12: Novel Crotch Absorber for LOREA. (a) The complete absorber. (b) Opening inlet reference. (c) Opening back reference.

COMPUTING

Óscar Matilla, acting Head of the Computing & Control Division

2018 has been an intense year. When passing from the conceptual to the design phase, the four beamlines under construction have demanded increased efforts. As a consequence, the different Computing support groups had to improve their efficiency for combining them with the operational demands. This has affected the time spent on operating beamlines which decreased from 15,664 to 13,032 hours with respect to the last year. But this just appears to be the tip of the iceberg in comparison to what will come during the forthcoming years when those beamlines will enter in their installation and commissioning phase. From a wider perspective, in 2018 most of the Computing time was spent on Experiments 33%, followed by Accelerators 19%, Computing 15%, CELLS general services 14% and collaborations with other institutions 10% (see details in figures).

In parallel, as a mature infrastructure of already eight years in operation, maintenance activities obligations have also increased. For example, the Controls and IT Systems group had to manage the change of the operating system used in the Controls System to Debian 9, hardware aging problems due to premature ripening appeared in the bending power supply booster and Service Area network aggregator switches arrived at the end of their life. In the case of the IT infrastructures, new requirements continuously appear which involve increasing their capabilities: during this year new Data Storage servers have been acquired both for digital office and beamlines experimental data, and the first phase of new servers for the High Performance Computing (HPC) cluster have been installed (including GPU high-end cards).

In addition to the day assurance of the operation, which consumes most of the time of the Computing staff, new technological challenges are envisaged in the horizon. In electronics, Field Programmable Gate Arrays (FPGA) have made widely available processing in the sub-mi-

cro second time range. This has been used in the electrometer Em# instrument to extend its synchronization capabilities and it shall be the basis of our future synchronization architecture for an improved data acquisition system. In data management, the Great Wave is expected in the following years: the quantity of data that new detectors produce is unprecedented; but so are the requirements for putting in practice the FAIR data principles (Findable, Accessible, Interoperable and Reusable) which the European Union is boosting and that shall converge in the future European Open Science Cloud (EOSC). This reality still seems far from our daily activity, but in fact, during this year some actions have been done to align the sails of the boat to the New World course: for instance, in NCD-SWEET first prototype using ICAT data catalogue has been tested, in XALOC, MXCuBE and ISPyB have been deployed as an enriched data acquisition and analysis platform, and in MIRAS the first remote data analysis has been offered to the users using virtual desktops.

After an exciting 2018, the forthcoming year will bring plenty of operational support needs, the new beamlines construction will continue and demanding technical challenges will appear. It will be thanks to the 50 people of the Computing division that we will be able to turn this predicted future into reality. And as the computer scientist Alan Kay stated “The best way to predict the future is to invent it.”.

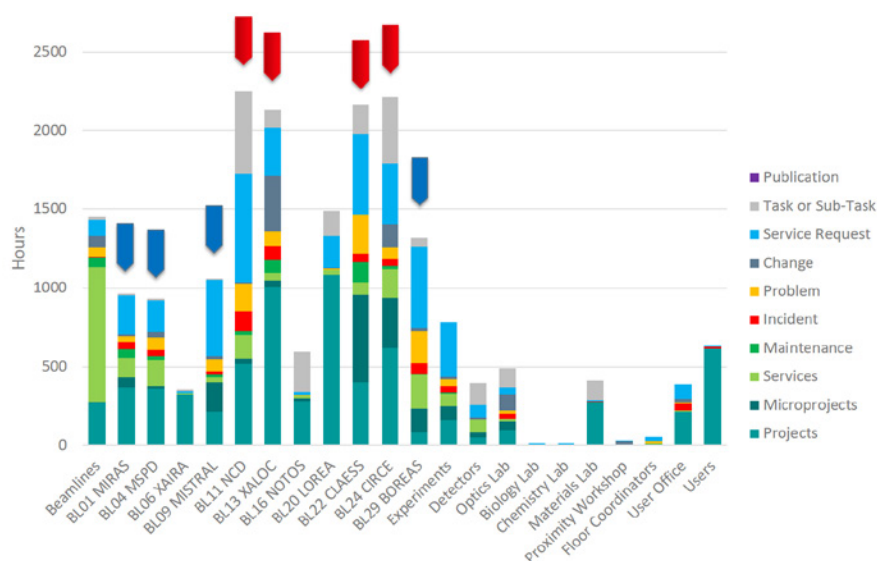

Project management, operation and knowledge sharing beyond the Computing Division

Daniel Salvat, Head of the Management and Information Systems Section (Computing & Control Division)

In 2016, after five years of operation, ALBA embarked on numerous complex projects again, such as the design and construction of the new beamlines. This time, support teams had the challenge to deal with such complexity, and still provide the level of service required to ensure the operation.

Having the Project Management, Product Development and Service Operations provided by the same teams, and between teams, involved coordinating multiple and different tasks and activities. MIS challenge was, at that time, to provide a tool to cover as many use cases as teams in need of it.

Agility and flexibility regarding workflow design and user interaction were crucial in order to gain experience for the optimization of the workflows and their efficiency.

The Atlassian suite, Jira (Service Desk and Software) and Confluence, was rapidly selected as the best choice after conducting a market study, including polling colleagues from other synchrotrons. Jira was a perfect fit for Computing's ITIL best practices (Service Management), as well as PRINCE2 (Project Management) methodology, which was put in place several years before.

Confluence was also perceived as the best additional feature to enrich the information provided by Jira. Both integrations allowed stakeholders to have a complete overview of the status of the project they may be interested in. User experience (UX) was also key for quick adoption, given the flexibility and ease of use of the tool.

Other use cases and "guinea pigs" were quickly identified,

and many other groups and sections declared having a similar need for Service Operations, beyond the Computing Division. Quicker than expected, groups such as Safety, Beamline Technicians, Engineering,...adopted the tool and asked for workflow customization, and design support.

Once the adoption was mature enough, the rest of the organization, who were not actively involved during the initial phases, naturally agreed and eventually promoted the use of Confluence, Jira and their complements to manage projects at a bigger scale.

Today, over 15,000 issues/tasks are created every year. And the number of Teams using this tool has increased from 4 (MIS, Controls, IT Systems, and Electronics) to 14 (+ Accelerators, Beamline Support, Communication, Experiments, H&S, Industrial Office, Infrastructures Engineering, Transversal Engineering).

In Confluence, 79 spaces are managed, containing 39458 pages, and all Divisions are also involved in content creation. Jira and Confluence are today the platforms upon which current activities rely on. The future of other activities, such as asset management or Gantt charts for better planning and visualization, are in the kitchen and ready to be served soon.

Results

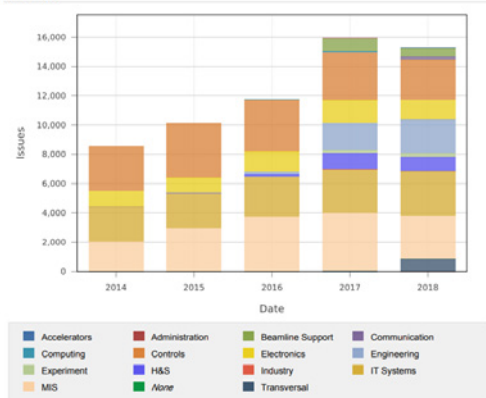

The number of tasks and issues managed by the different teams started with the Computing (MIS, Controls, IT Systems, and Electronics) Division in 2015 and 2016. By the end of 2017, Beamline Support, H&S, and the Engineering Division were actively involved in Service Management using Jira. The figure shows the number of issues created by all involved Divisions. At this point, and given the fact that we have reached to almost all the Divisions, except Administration, on the usage of Jira as the tool for managing service (inside or outside IT) and projects, we consider the establishment of integrated service management at ALBA as completed.

HEALTH & SAFETY



During 2018, the Health & Safety Office has developed its routine service activity, guaranteeing that standards on conventional safety and the levels of radiation outside the shielding enclosures allow public access to the area.

In particular, conventional safety activities have been based on developing the tools described in ALBA's recently approved prevention plan published at ALBA's intranet (<https://confluence.cells.es/display/HSI/DATA+ROOM+SAFETY+OFFICE>) and presented to all ALBA staff in annual training course. During this period, actions coming from psychosocial risk assessment and from mobility survey have been put in place. For instance, a counselling service and carpooling tool are already available for the whole staff. A new electrical risk safety rule has been discussed with a working group created ad-hoc during 2018, which is to be approved during 2019. Regarding emergencies, a chemical safety shower for laboratories and a waste warehouse have been installed. Besides this, chemical and biological labs have implemented the segregation of hazardous compounds by incompatibilities.

On the other hand, the Radioprotection Service (SPR) has studied the operational experience of the ALBA Radiofrequency Laboratory (RF LAB) and performed specific radiation measurements inside and outside the area. With the data obtained, the RF LAB outside the RF LAB Bunker has been reclassified as a public access area (dole limit under 1mSv/year). Therefore, at the end of 2018 the SPR has reclassified the RF LAB as a public access area. On the other hand, during 2018 the SPR has completed the initial project of radon concentration measurements at ALBA, in collaboration with the UAB Technical Unit of Radiation Protection (UTPR). The main conclusions are that radon concentration values at the ALBA Synchrotron facility are below the established annual limits, so they do not represent a significant risk for workers. These results have been presented to the staff in a specific briefing as part of general radiation protection information outreach. Finally, during the summer shutdown, the SPR has successfully completed the functional verification of the 9th beamline BL20-LOREA Personal Safety System (PSS) and its final implementation within ALBA's PSS.

PROJECTS & COLLABORATIONS

ALBA has been granted European Regional Development Funds (ERDF) through the Spanish and Catalan administrations for long-term period projects. Besides, in 2018 ALBA has participated in different international and national collaborations with other facilities and research centres.

10,278,381.5 € ERDF Funds (2018-2023)



628,700 € 2018 Competitive Call

432,800 € 2018 Agreements

PROJECTS CO-FUNDED BY THE EUROPEAN REGIONAL DEVELOPMENT FUNDS (ERDF)



Fondo Europeo de Desarrollo Regional
"Una manera de hacer Europa"

UNIÓN EUROPEA



- Design and construction of the phase-III beamline XAIRA
- Improvement of phase-I infrastructures (NCD beamline and Booster)
- Design and construction of the phase-III beamline NOTOS
- Update of the data management infrastructure
- Improvements in the reliability of the radiofrequency (RF) transmitters used by the ALBA accelerator rings
- Transversal electronics equipment and cabling systems for new and operational beamlines
- Transversal standard vacuum technology and equipment for new and operational beamlines

EUROPEAN PROJECTS IN WHICH ALBA PARTICIPATES



Integrating Activity project that aims to develop European particle accelerator infrastructures, improving the performance, availability, and sustainability of particle accelerators, transferring the benefits and applications of accelerator technology to both science and society, and enlarging and integrating the European accelerator community.



Knowledge transfer to the scientific community emerging around SESAME, the synchrotron facility of the Middle East. The project includes training activities (courses, schools, etc.) and staff exchanges.



Project for designing a hard X-ray FEL facility beyond today's state of the art, using the latest concepts for bright electron photo injectors, very high-gradient X-band structures at 12 GHz, and innovative compact short-period undulators.



Project for designing, building and starting a beamline for X-ray tomography at SESAME synchrotron lightsource in Jordan.



Doctoral training programme in Functional Advanced Materials



With the goal of removing barriers for access to world-class accelerator-based light sources in Europe and in the Middle East. More than 82,500 hours of trans-national access are provided to these research infrastructures and specific programmes are in place to teach new users how to successfully use synchrotrons and FELs.



Project for developing a model describing the socio-economic impact of research infrastructures (RIs) and their related financial investments.

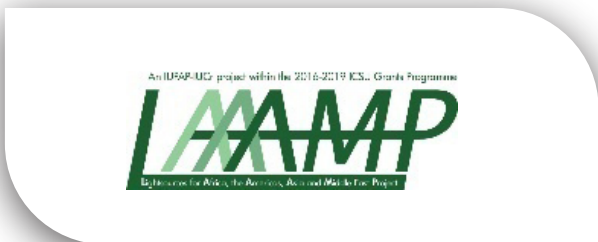

Utilization of Light Source and Crystallographic Sciences to Facilitate the Enhancement of Knowledge and Improve the Economic and Social Conditions in Targeted Regions of the World, ICSU is a partner with IUPAP and IUCr.



Conceptual design study for a post-LHC research infrastructure based on an energy-frontier 100 TeV circular hadron collider. ALBA's role is to contribute to the management of accelerator developments, organisation of international events and vacuum design.



New insights into the mechanisms underlying the amplification of radiation effects of nanoparticles, both in conventional and in charged particle therapy.



Project for putting together SMEs and research centres in the border regions of Spain and France to promote cooperation in R&D&I and technology transfer

EDUCATION & OUTREACH

Dissemination and training on synchrotron light applications and the operation of the facility are at the core of the ALBA Synchrotron. The goal is to transmit and share knowledge with the scientific community, staff or students and also to inform the general public about ALBA's activities and performance.

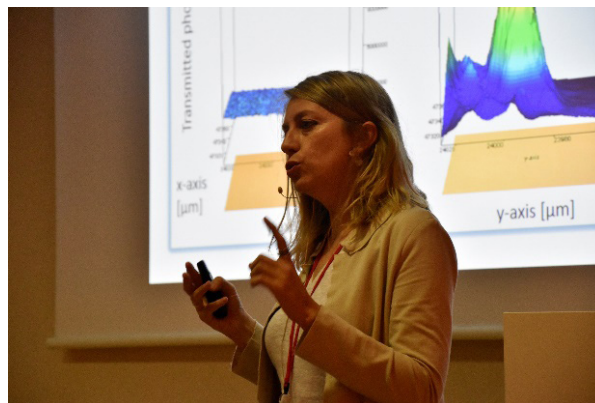

Participants at the 4th Assets Maintenance and Management Workshop (left). Speaker Tanja Dudic during FTIR microspectroscopy workshop (right).

LEARNING FROM OTHERS

ALBA is deeply active in the organisation of seminars and workshops where to exchange the latest of a wide variety of research fields. In 2018 ALBA has organised more than 40 events. 15 external speakers were invited to share the latest news of accelerators' technology and synchrotron light applications. The cycle of internal seminars, ALBA Talks - aimed at promoting scientific knowledge among the ALBA staff -, hosted 10 talks by staff members or invited speakers. A total of 15 workshops were organised by ALBA, some of which within the framework of European projects (CALIPSOplus, RI-PATHS, ARIES workshops and CompactLight XLS Meeting). Three workshops were focused on expanding knowledge about experimental techniques. The 4th Assets Maintenance and Management Workshop, organised by the Computing and Engineering division, was also held at ALBA's premises.

TRAINING FOR THE FUTURE

The Students' Program hosts every year more than 30 students in ALBA who are trained in different disciplines: engineering, accelerators' technologies, synchrotron light experimental applications, computing and controls, health & safety, administration and finances or communication.

In 2018, 14 university undergraduates and 13 vocational training students have done internships at our facility. Nine PhD students were developing their thesis under the guidance of the Accelerators, Experiments and Engineering divisions. The 5th of October, the 2nd Early-stage Researchers Day was held at ALBA. Members of the ALBA staff also participate in university teaching activities within the degree of Physics at the UAB and at some masters from the UPC.



PhD students of the 2nd early-stage Researchers Day with Francis Pérez (head of the Accelerators division), Caterina Biscari (director of ALBA) and Miguel Ángel García Aranda (head of the Experiments division).

REACHING THE GENERAL PUBLIC

In 2018 we continued conveying to the general public how the facility works and which its main research activities are. In 2018, there has been an increase in the production of scientific news – distributed via website, social networks and conventional media-, reaching a media impact equivalent of 628,000 € advertising rates.

More than 7,000 people visited ALBA in 2018, in guided tours or during the ALBA Open Day that, one more year, became a great success with the highest number of visitors in one day (2,320) and the collaboration of 116 volunteers from the staff.

2018 was the year when a new educational project, addressed to primary schools from all Spain, has been launched. Misión ALBA was designed to offer 10-12 year-olds resources for experimenting with science at the classroom and for getting in contact with a real scientific environment with the end of promoting scientific vocations.

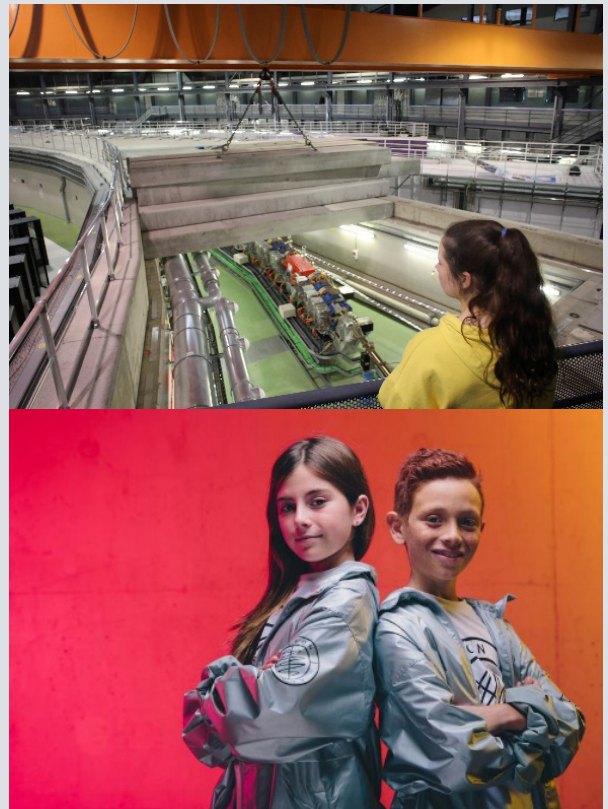

Above, one of the visitors during the ALBA Open Day 2018. Below, central image of Misión ALBA project.



7,028 visitors
2,507 high school visitors



36 students



43 events organised
15 workshops



321 media impacts

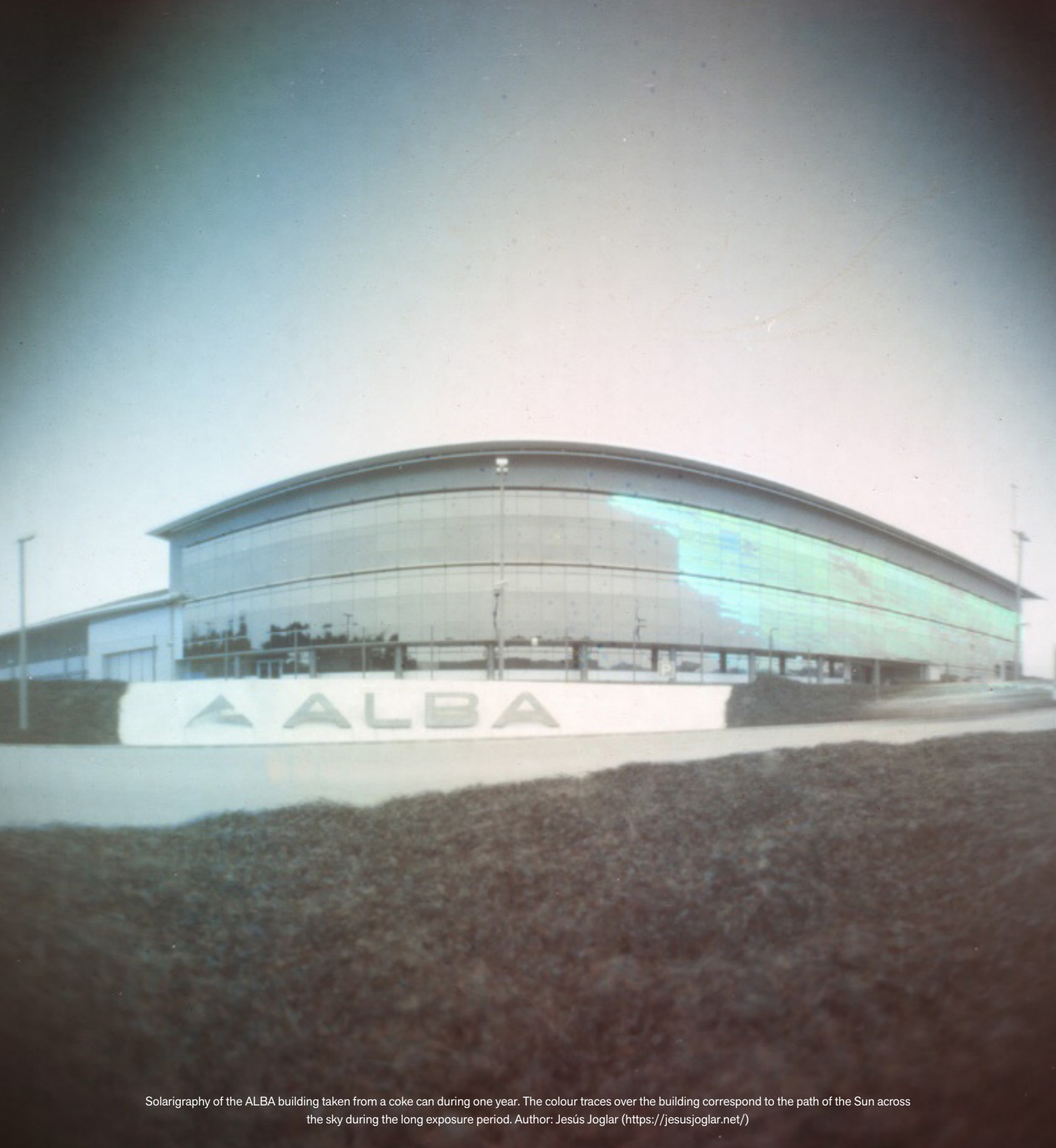

Solarigraphy of the ALBA building taken from a coke can during one year. The colour traces over the building correspond to the path of the Sun across the sky during the long exposure period. Author: Jesús Joglar (<https://jesusjoglar.net/>)



ALBA Synchrotron - www.albasynchrotron.es
Carrer de la Llum 2-26, 08290 Cerdanyola del Vallès (Barcelona) Spain / Tel. +34 93 592 4300