

MAXIN

The image shows the word "MAXIN" in a bold, grey, sans-serif font. A bright yellow, curved swoosh underline starts under the 'M', loops under the 'A' and 'X', and ends under the 'N'. The swoosh has a slight curve and a thin tail at the end.



The MAX IV Thermionic pre-Injector

David Olsson

ESLS RF, Lund, 2015-09-30

Injection Requirements I

- Full-energy injection from the LINAC 1.5 GeV and 3 GeV extraction points.
- Both storage rings will be operated with top-up injections that are as transparent as possible for the users.
- Nonlinear injection kickers (MAX IV, SOLEIL, BESSY collaboration) do not perturbate the stored beam*.
- High-energy electron losses should be minimized
 - Damage to electronic equipment and to personnel
 - Demagnetization of IDs → reduced K and broadening of spectral lines
- Unavoidable high-energy electron losses
 - Ring current decay (Touschek scattering)
- Avoidable high-energy electron losses
 - Charges injected outside the MA and/or PA of the ring buckets
 - Charges injected outside the MA of the transport lines and the ring lattice
- The chopper system minimizes the avoidable losses and maximizes the injection efficiency.

*S. C. Leemann, et al., "Progress on Pulsed Multipole Injection for the MAX IV Storage Rings"

Injection Requirements II

- The thermionic RF gun delivers a current pulse that is several hundred nanoseconds long and consists of S-band bunches.
- The number of S-band bunches that can be accumulated in each ring bucket depends on
 - Available RF voltage
 - Number of IDs and damping wigglers
 - Gap in IDs (varies during a shift)
- The Table shows the bucket acceptance in the 3 GeV ring for the bare lattice*.
- In the 1.5 GeV ring, it is possible to inject at least up to 15 S-band bunches per ring bucket.
- A LINAC pulse should contain a number of bunch trains that are separated by 10 ns. Each bunch train should contain the desired number of S-band bunches.

U_{cav} [MV]	δ_{RF} [%]	# S-band bunches
1.80	± 7.1	3-4
1.00	± 4.5	5
0.60	± 2.4	7

Bucket acceptance in the 3 GeV ring (bare lattice)

Example

11 bunch trains with 3 S-band bunches in each bunch train.

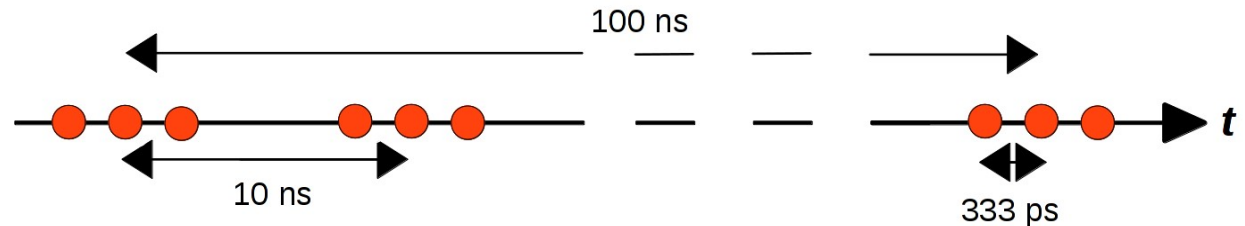

*S. C. Leemann, priv. comm.

The Thermionic pre-Injector

- The MAX IV thermionic pre-injector is used for ring injections, and is almost identical to the one in the present MAX-lab*.
- The thermionic gun is a 3-cell S-band RF gun with a heated BaO cathode. The gun is fed by a 1 μ s long pulse at \sim 6 MW. Charges up to 20 pC per S-band bunch can be delivered to the LINAC.
- The photo-cathode gun delivers a high-charge, low-emittance bunch, and operates as a driver for the SPF (and future FEL) between ring injections.
- The energy filter is ramped during injections.

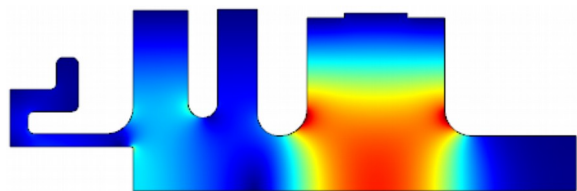

$|\mathbf{E}(\mathbf{r})|$ of the accelerating $\pi/2$ mode in the thermionic RF gun.

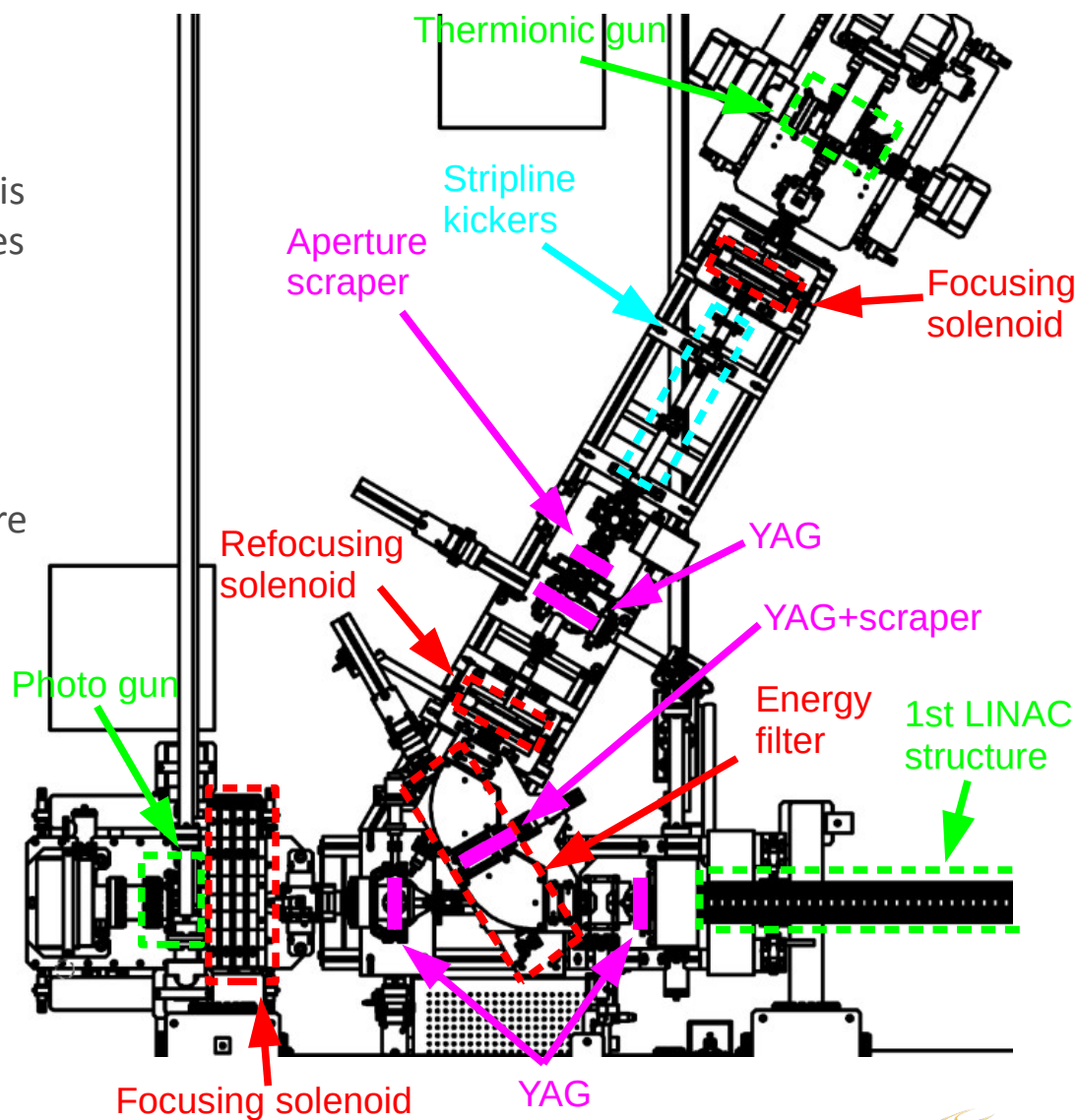

*B. Anderberg, et al., "The design of a 3 GHz thermionic RF-gun and energy filter for MAX-lab"

The Chopper System I

- Consists of two in-house constructed planar stripline kickers*.
- The first stripline is fed by a superposed RF signal, and the second one is fed by two DC pulses.
- Each stripline has a vertical corrector placed around it, and only electrons that are within the correct time structure are experiencing a vertical net force that is zero. The corrector currents are monitored by the PSS system.
- The aperture scraper consists of a moveable plate with one 1 mm hole and one 2 mm hole. One can select the obstacle by adjusting the plate.
- Unwanted electrons are dumped at the aperture scraper and in the energy filter.

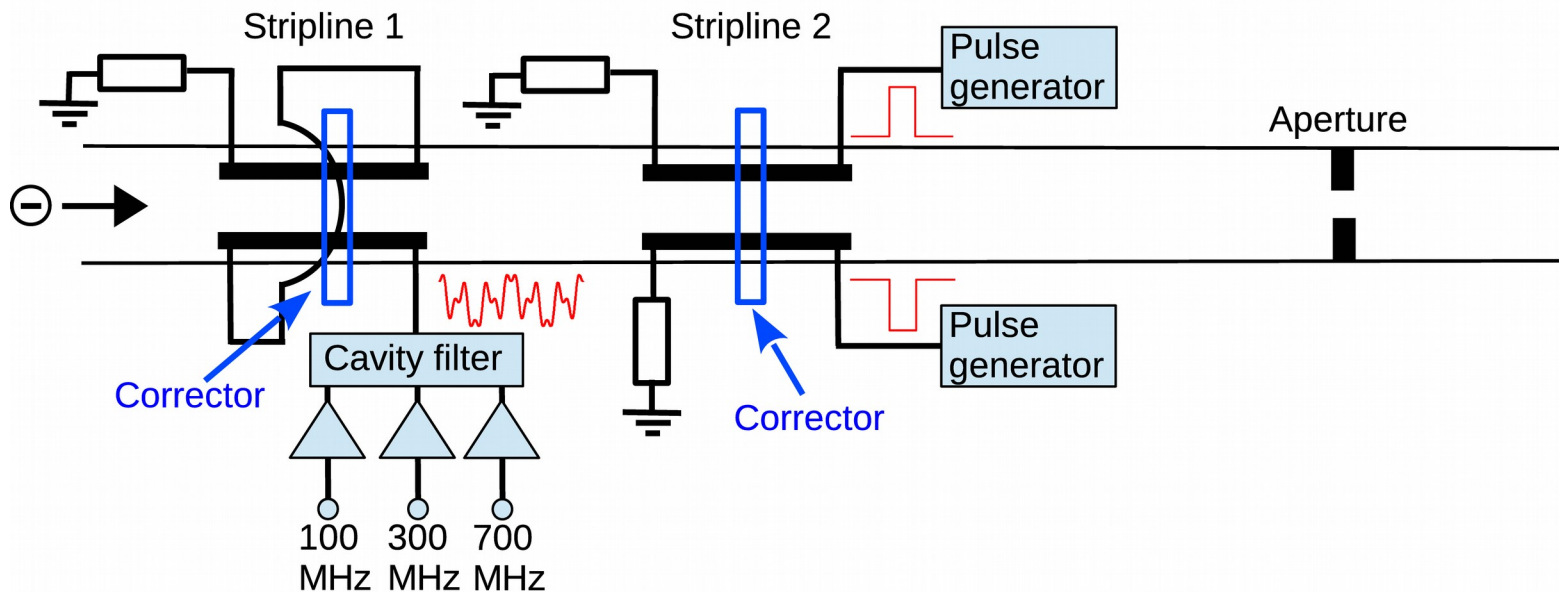

*D. Olsson, et al., "A Chopper System for the MAX IV Thermionic pre-Injector"

The Chopper System II

- Three RF signals of 100 MHz, 300 MHz, and 700 MHz are fed to the first stripline.
- By adjusting the phase/amplitude of the three signals, one can set the number of S-band bunches that are injected into each ring bucket.
- During early ring commissioning, a single 500 MHz signal is used instead since it maximizes the BPM response (1-2 out of 6 S-band bunches are kept).
- The RF signals are circulated from Port 3 to Port 2. Odd TEM mode ($Z_0 = 50 \Omega$) when $f = (n + 1)100$ MHz, and even TEM mode ($Z_0 = 88 \Omega$) when $f = n200$ MHz, $n \in \mathbb{N}$.

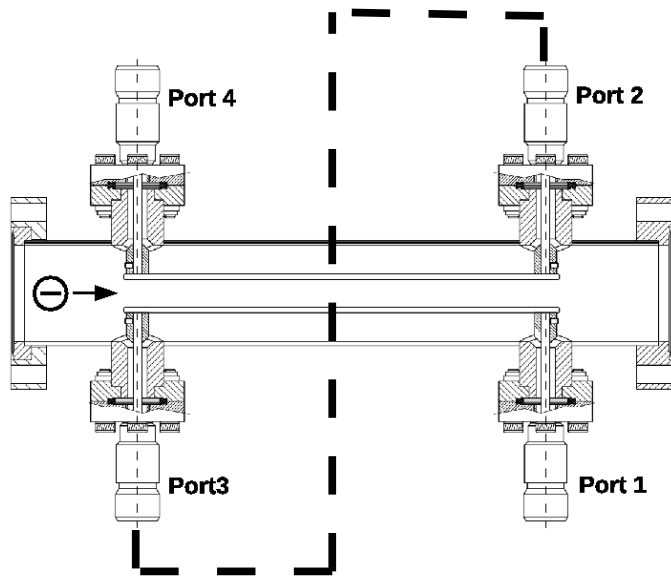

Port numbering of the first stripline

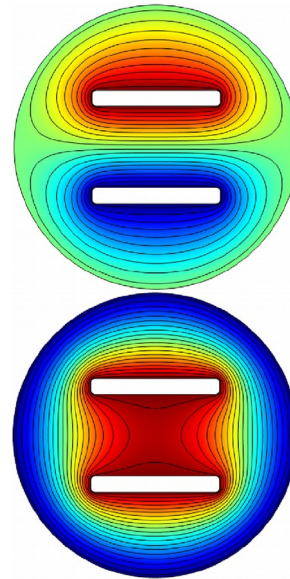

$\Phi(\mathbf{r})$ of the odd (top) and even (bottom) TEM mode

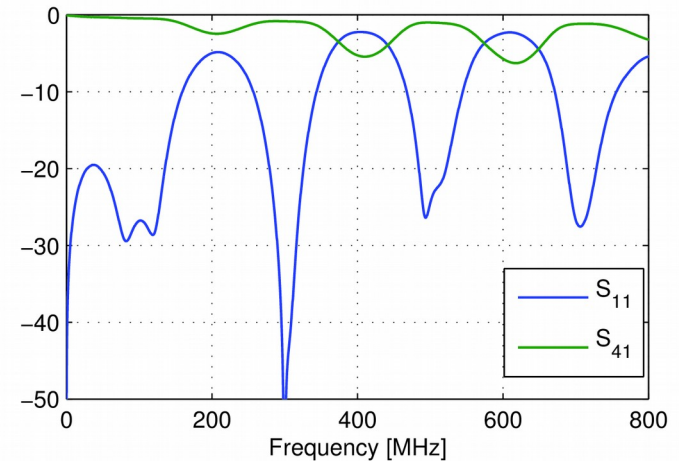

S-parameters of the circulated stripline

The Chopper System III

Example: Selecting 5 S-band bunches per ring bucket (5 bunches per 10 ns period). The 2 mm aperture hole is inserted.

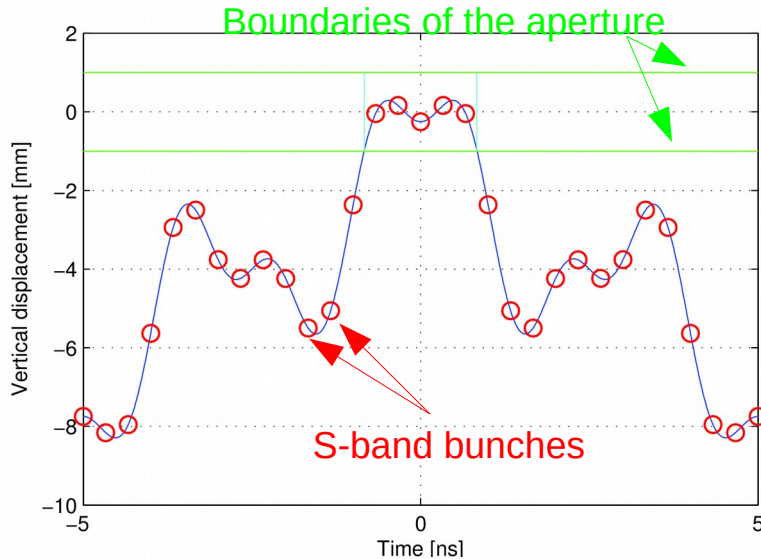

Top Left: Simulated transverse displacement in TD of the S-band bunches at the position of the aperture scraper.

Bottom Left: Simulated charge projection at the aperture scraper without any offset.

Bottom Right: Measured charge projection on a YAG screen directly after the aperture scraper without offset. Note that the aperture obstacle is removed and the etched square is enhanced.

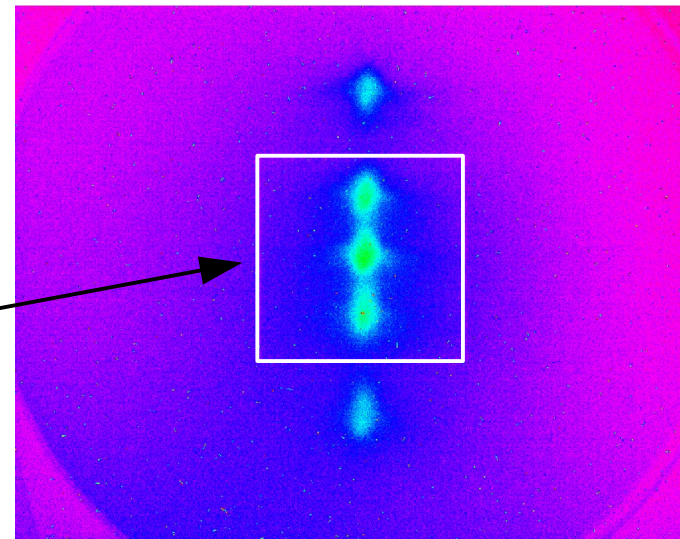
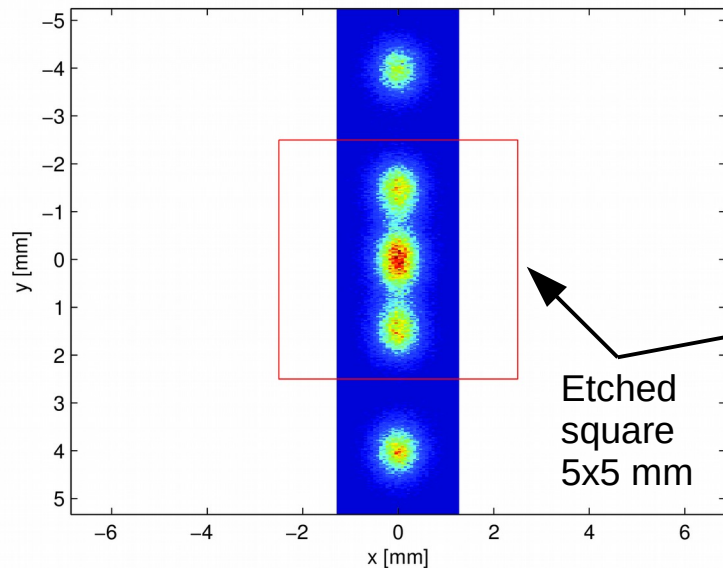

The Chopper System IV

- The harmonics of the 100 MHz signal are generated as overtones from the main RF frequencies of the two rings. By doing so, the chopper is always synchronized to the buckets in the ring where the injection occur.
- Due to the rise/fall time of the cavity combining filter and the amplifiers, the RF to the first stripline is turned on before the RF gun. Therefore, the vertical deflecting fields in the stripline has reached saturation when the electrons arrive.
- The chopper exciter network and the amplifiers are constructed in-house*.

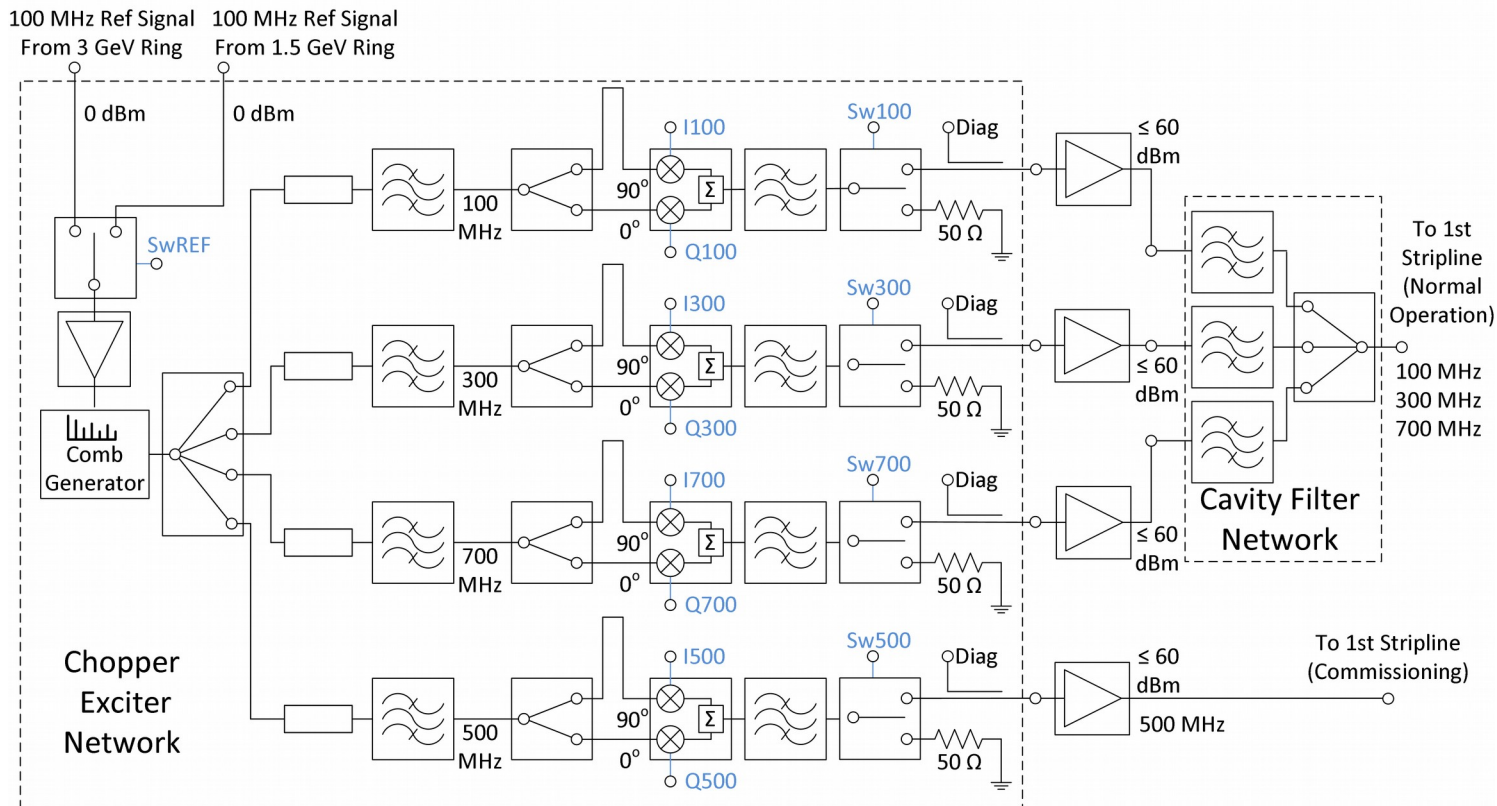

*Constructed by Sven-Olof Heed and Robert Lindvall

The Chopper System V

- The two electrodes of the second stripline are fed with DC pulses of different polarities (odd TEM). The DC pulses are generated by commercial switch modules.
- By adjusting the width of the DC pulses, one can set the number of ring buckets that are filled in each LINAC shot.
- Injecting with exotic (non-uniform) filling patterns is possible.
- Gap clearing can also be performed after injection using RF knock out with the transverse bunch-by-bunch feedback system (currently under development).
- The transport lines have a momentum acceptance of $\pm 0.8\%$. This limits the length of the injected current pulse due to the energy chirp created by the SLED systems.
- For higher injected current, beam loading in the LINAC reduces the energy chirp.
- Note that the energy chirp in the LINAC shot decreases the phase window in each ring bucket where charges can be accumulated due to the rotation in phase-space.

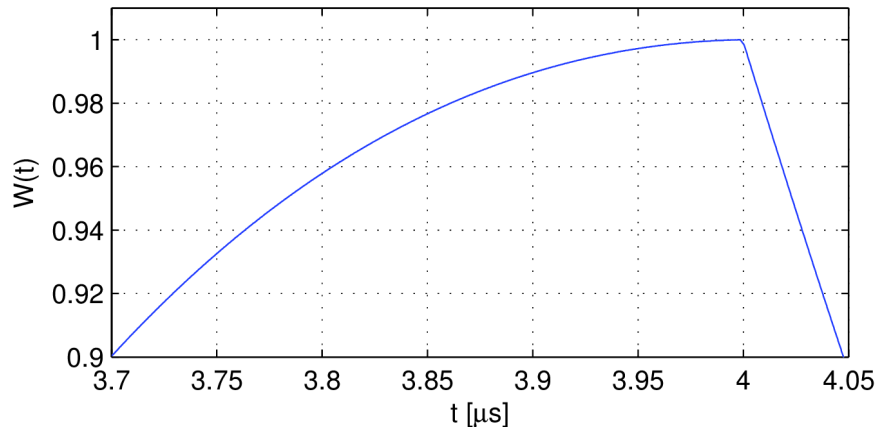

The normalized energy gain $W(t) = \int E_z(z, t) dz$ of a MAX IV LINAC structure without beam loading as a function of the electron release time, t .

The Chopper System VI

- The electron current in the thermionic pre-injector is measured at three different locations using CTs. The bunch structure can also be studied at BPM striplines along the LINAC.

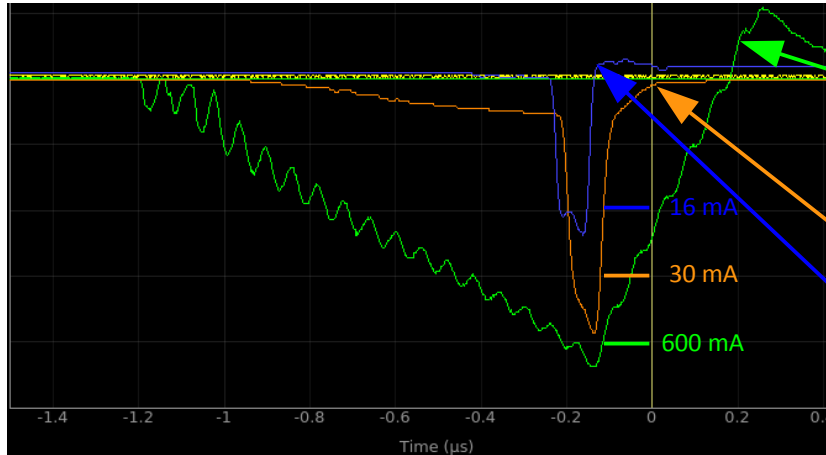

The electron current during ring commissioning measured with three different CTs. Note that the scale is different for the curves.

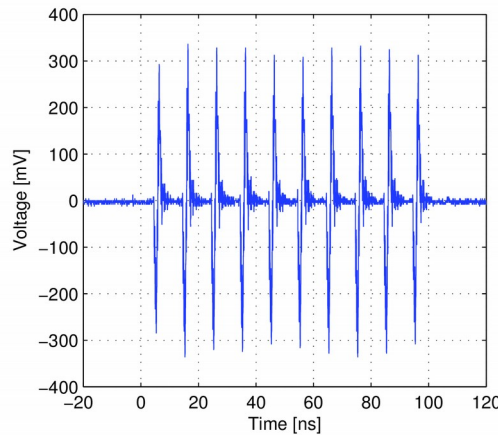
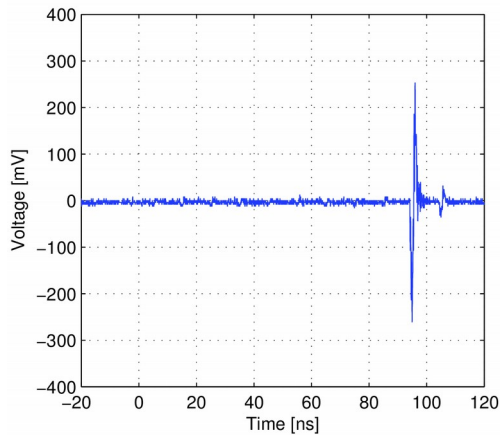

The induced voltage at a BPM strip after two LINAC structures ($W = 190$ MeV). Here, one (left) and ten (right) ring buckets are filled.

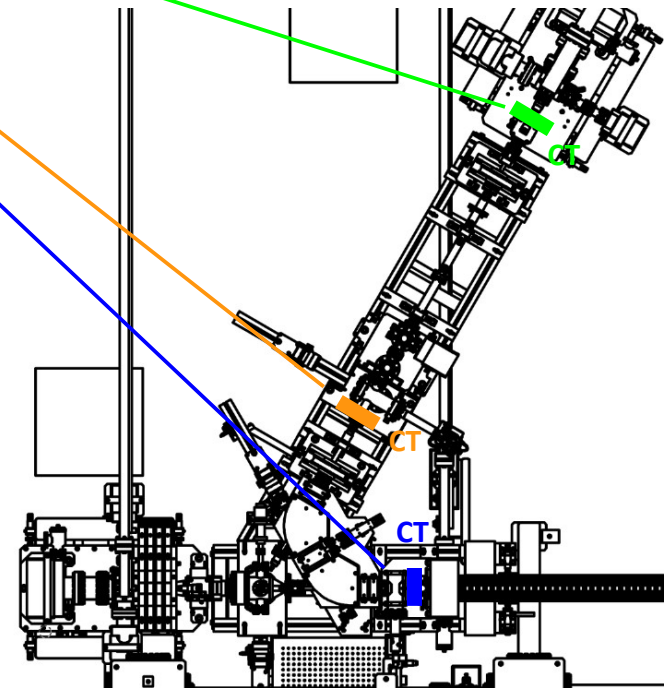

Measurement Series (April 2015)

- Simulations/measurements of different driving schemes
- Assumptions
 - All electrons that pass the aperture scraper have the same energy
 - Discrete S-band bunches with charge q_b
 - Normalized Gaussian transverse charge distribution $\lambda_{\perp}(\mathbf{r})$ with σ and its center at \mathbf{r}_0
- For a circular aperture scraper with radius a and its center at \mathbf{r}_1 , the normalized throughput of an S-band bunch becomes

$$\int_S \lambda_{\perp}(\mathbf{r}, \mathbf{r}_0) da = \dots = 1 - e^{-\frac{|\mathbf{r}_1 - \mathbf{r}_0|^2 + a^2}{\sigma^2}} \sum_{n=0}^{\infty} \left(\frac{|\mathbf{r}_1 - \mathbf{r}_0|}{a} \right)^n I_n \left(\frac{a|\mathbf{r}_1 - \mathbf{r}_0|}{\sigma^2} \right)$$

- If the transverse deflection is vertical, then $\mathbf{r}_0(t) = y(t)\hat{\mathbf{y}}$

$$y(t) = y_0 + \sum_{n=1}^N y_n \cos(\omega_n t)$$

- The current after the aperture scraper then becomes

$$i(t) = q_b \sum_{n=-\infty}^{\infty} \delta(t - nT_b) \int_S \lambda_{\perp}(\mathbf{r}, y(t)\hat{\mathbf{y}}) da$$

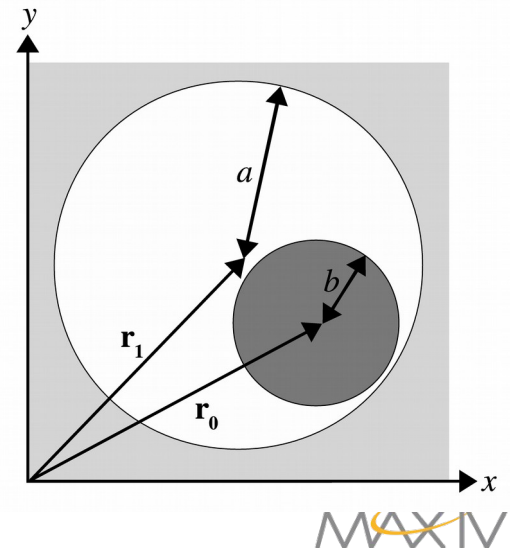

Measurement Series (April 2015)

- The average peak current is measured after the energy filter
- Compensating the assumptions with a conservative beam size ($\sigma = 0.5$ mm)
- Driving schemes optimized for 3, 5, 7, 9, 11, 13, and 15 S-band bunches per ring bucket. Largest allowed charge outside the time window per 10 ns is $0.05 Q_b$
- $\{f_1, f_2, f_3\} = \{100, 300, 700\}$ MHz
- 2 mm aperture scraper ($a = 1$ mm)
- YAG screen projections on the following slides.....

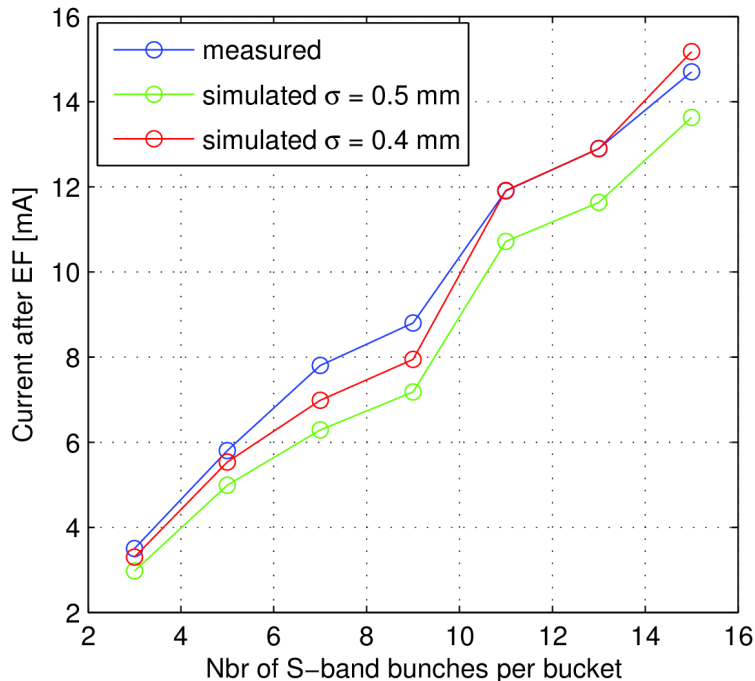

# S-band bunches	y_0 [mm]	y_1 [mm]	y_2 [mm]	y_3 [mm]	i after EF [mA]
3	-8	3.75	5.25	-0.75	3.5
5	-4	2.5	2.25	-1	5.8
7	-4.5	4.5	0.25	-0.5	7.8
9	-4.5	5	0	0	8.8
11	-4	4.75	-1	0.25	11.9
13	-3	3.75	-1	0	12.9
15	-1.5	2	-0.75	-0.25	14.7
30	0	0	0	0	35

Measurement Series (April 2015)

Note that this projection has an offset since it is larger than the YAG screen.

- 3 S-band bunches / ring bucket

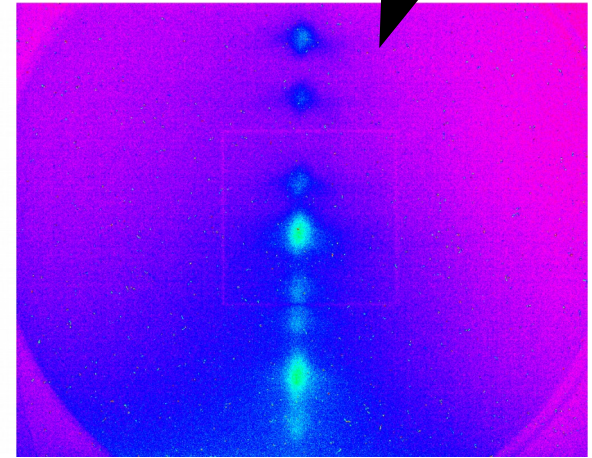
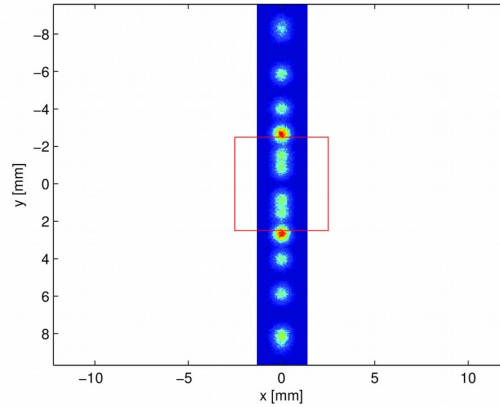
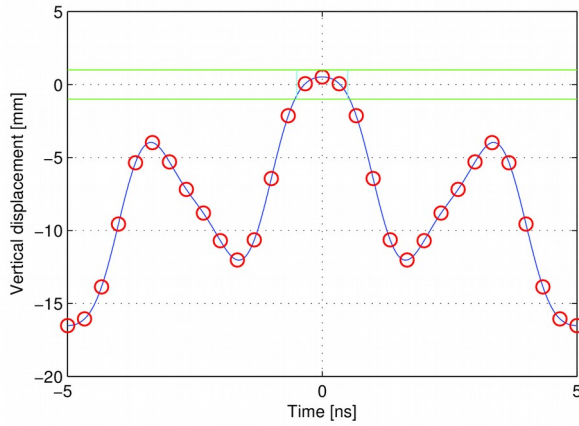

- 5 S-band bunches / ring bucket

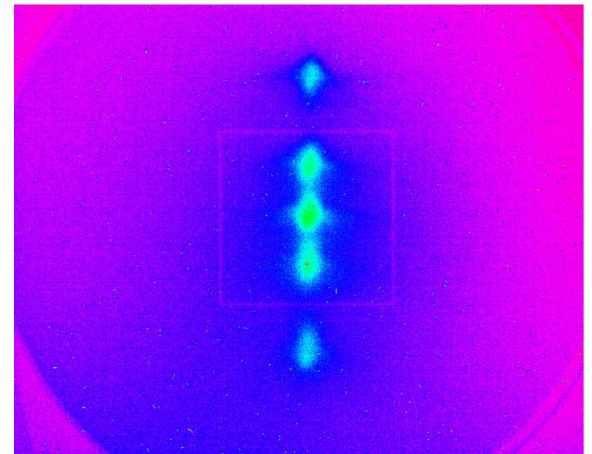
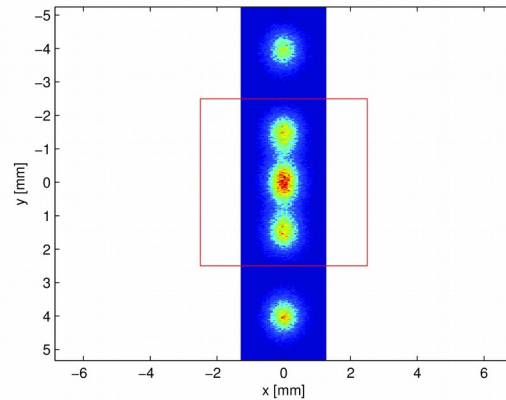
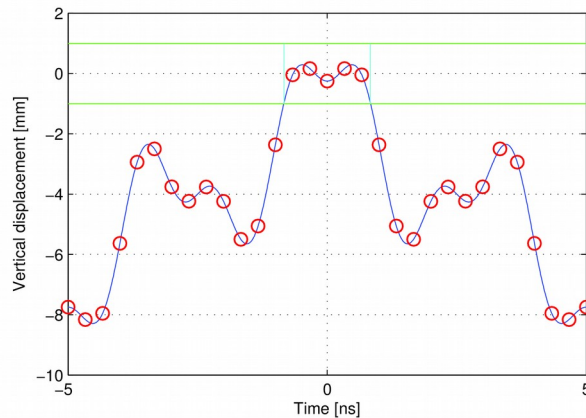

Measurement Series (April 2015)

- 7 S-band bunches / ring bucket

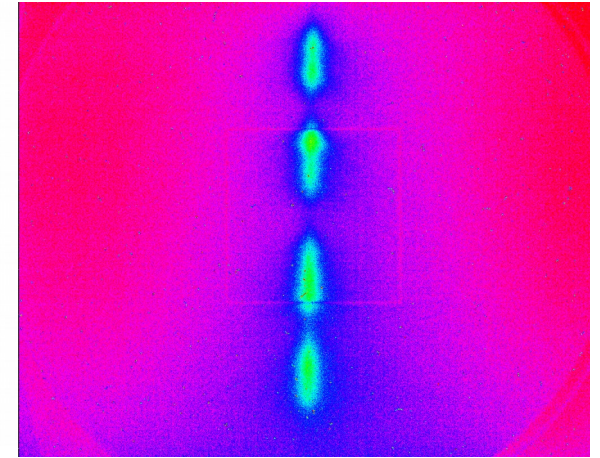
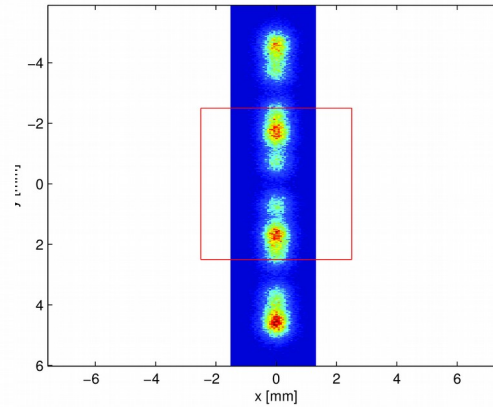
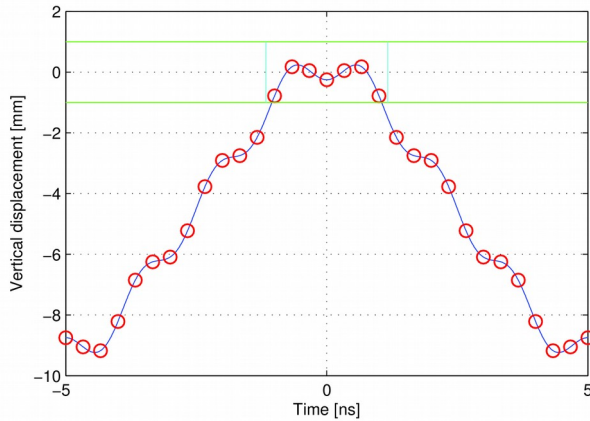

- 9 S-band bunches / ring bucket

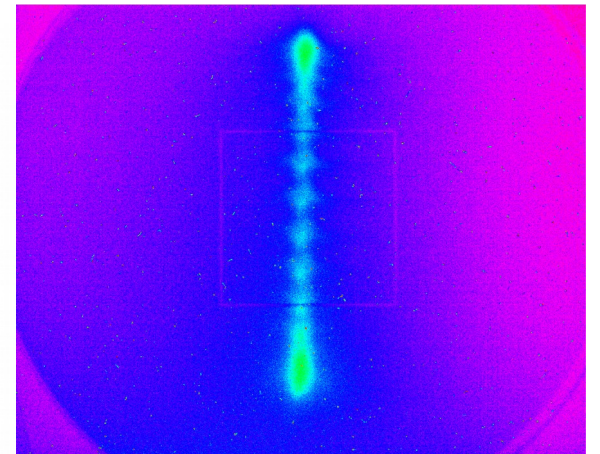
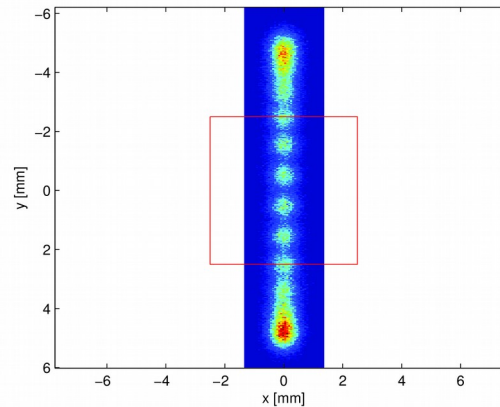
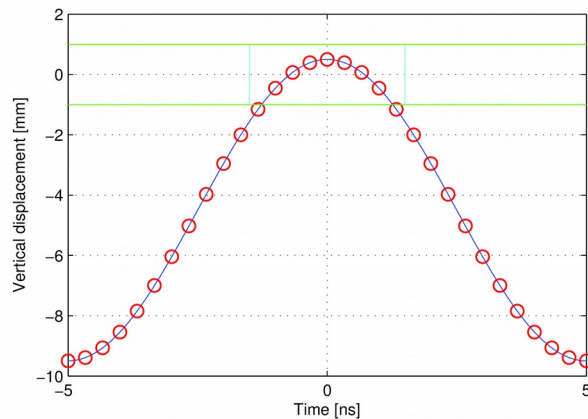

Measurement Series (April 2015)

- 11 S-band bunches / ring bucket

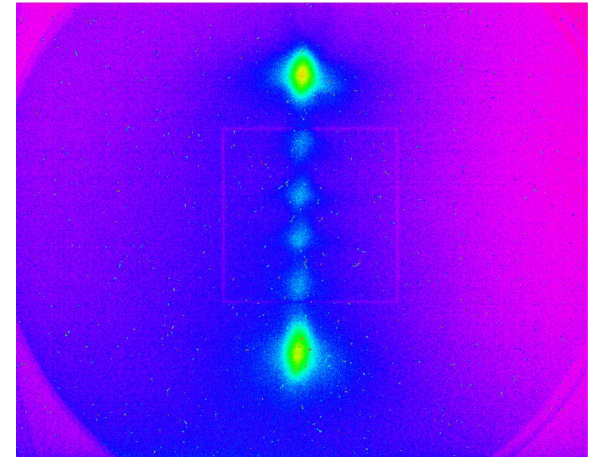
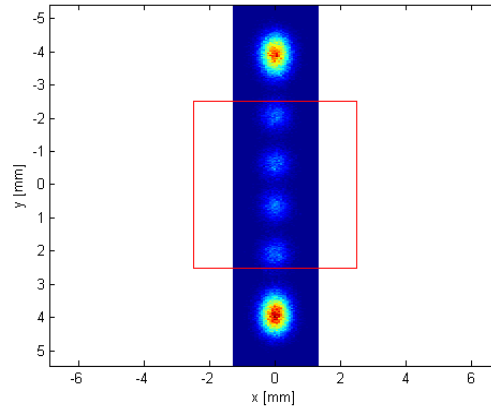
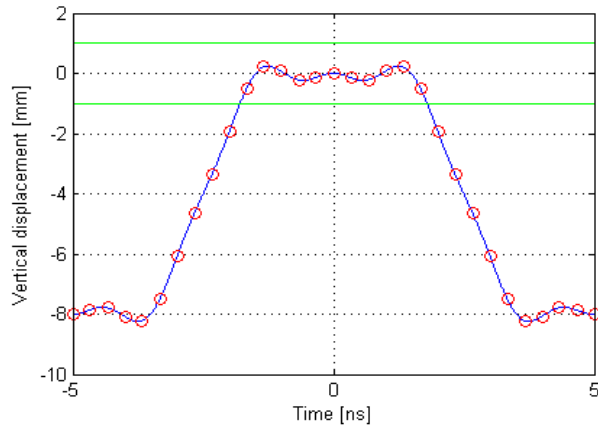

- 13 S-band bunches / ring bucket

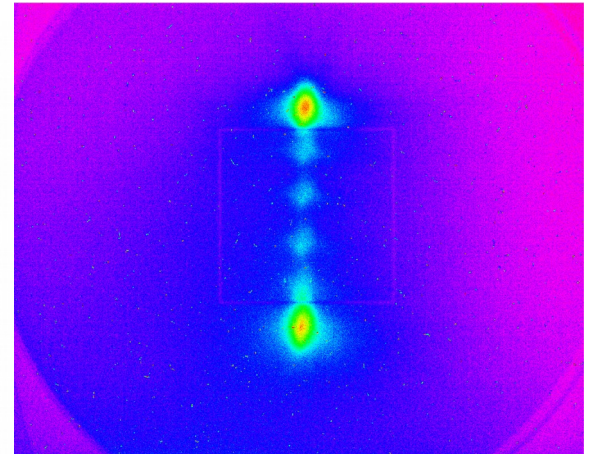
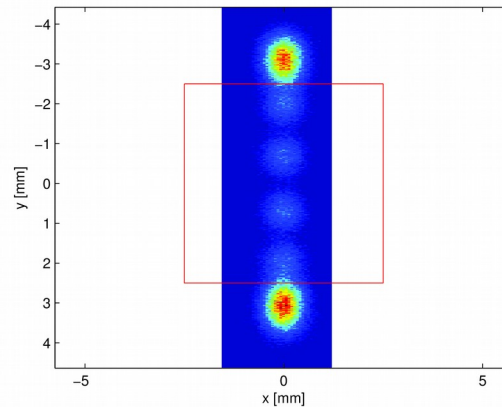
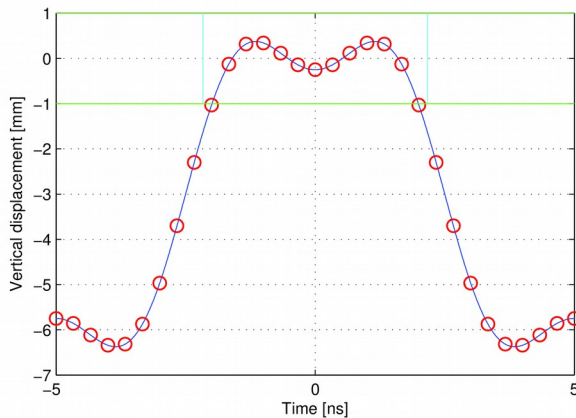

Measurement Series (April 2015)

- 15 S-band bunches / ring bucket

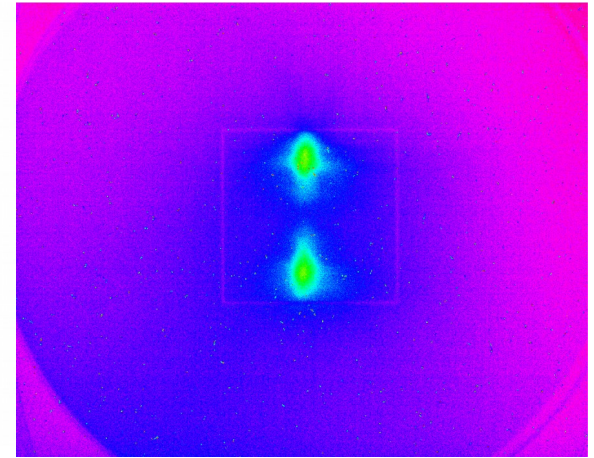
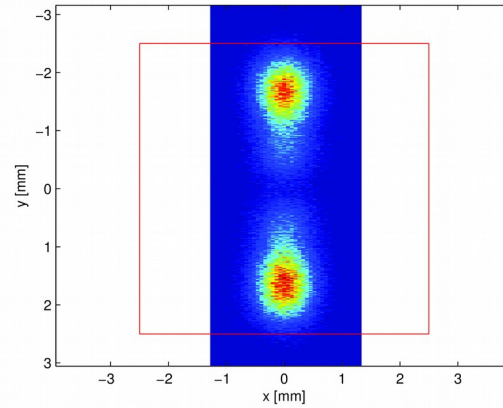
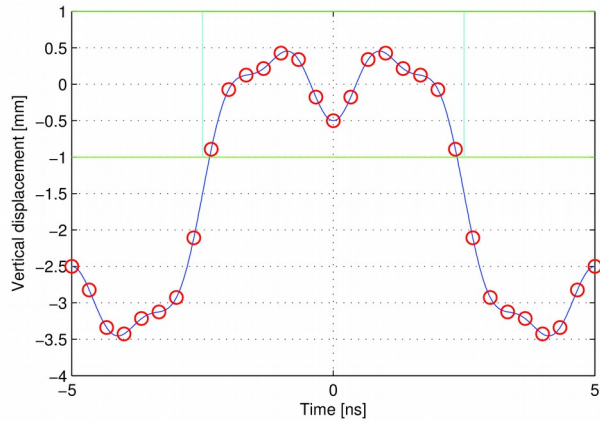

Thank you!